

Team Scores

Printed on 01/12/2025 11:13 a.m.

Team Scores		
1	Woodrow Wilson	547.0
2	Parkersburg	473.0
3	Cabell Midland	403.0
4	George Washington School	353.0
5	Cameron	327.5
6	Fairmont Senior	294.0
7	Preston Hs	293.5
8	Buckhannon-Upshur	273.5
9	Huntington	267.0
10	Morgantown	263.0
11	East Fairmont Hs	233.5
12	Greenbrier East	226.0
13	Oak Hill	167.0
14	North Marion	142.0
15	Waynesburg Central Hs	122.5

Tournament Results

106

Guaranteed Places

- 1st Place - Seth Drennen of Parkersburg
- 2nd Place - Bryson Simmons of Cabell Midland
- 3rd Place - Brayden Jones of Woodrow Wilson
- 4th Place - Aiden Linko of Parkersburg
- 5th Place - Kai Asano of Greenbrier East
- 6th Place - Maverick Lilley of Cameron
- 7th Place - Anabelle Ward of Cabell Midland
- 8th Place - Karson Brand of Fairmont Senior
- 9th Place - Kyra Hamilton of East Fairmont Hs
- 10th Place - Lucas Lilly of Preston Hs

1st Place Match

Seth Drennen (Parkersburg) 22-5, So. over Bryson Simmons (Cabell Midland) 28-3, Fr. (MD 12-1)

3rd Place Match

Brayden Jones (Woodrow Wilson) 31-5, Fr. over Aiden Linko (Parkersburg) 10-5, Fr. (Dec 6-4)

5th Place Match

Kai Asano (Greenbrier East) 20-8, So. over Maverick Lilley (Cameron) 11-10, Fr. (Dec 9-2)

7th Place Match

Anabelle Ward (Cabell Midland) 2-5, So. over Karson Brand (Fairmont Senior) 7-11, Sr. (Dec 6-0)

9th Place Match

Kyra Hamilton (East Fairmont Hs) 4-8, So. over Lucas Lilly (Preston Hs) 10-11, So. (MD 12-1)

11th Place Match

() , . over () , . (Bye)

Guaranteed Places

1st Place - Jackson Woods of Woodrow Wilson
2nd Place - Bryce Nichols of Fairmont Senior
3rd Place - Kayden Maynard of Cabell Midland
4th Place - Jeremy Jett of Buckhannon-Upshur
5th Place - Zach Shawver of George Washington School
6th Place - Austin Carrodus of Parkersburg
7th Place - Jackson Lilley of East Fairmont Hs
8th Place - Sonny Herbert of Greenbrier East
9th Place - Cayden Alejos of Cabell Midland
10th Place - Chase Sizemore of Oak Hill
11th Place - Forfeit Forfeit of Unattached
12th Place - Ava Lemasters of Cameron
12th Place - Brody Bryner of Preston Hs
13th Place - Payton Holstein of Oak Hill
14th Place - Aaron Braun of Morgantown
15th Place - Brady Davis of Morgantown
16th Place - Ellie Juarez of North Marion

1st Place Match

Jackson Woods (Woodrow Wilson) 26-4, Jr. over Bryce Nichols (Fairmont Senior) 25-4, Sr. (MD 14-6)

3rd Place Match

Kayden Maynard (Cabell Midland) 24-10, So. over Jeremy Jett (Buckhannon-Upshur) 14-4, Jr. (MD 16-3)

5th Place Match

Zach Shawver (George Washington School) 23-6, Fr. over Austin Carrodus (Parkersburg) 15-9, Fr. (MD 13-3)

7th Place Match

Jackson Lilley (East Fairmont Hs) 11-12, Sr. over Sonny Herbert (Greenbrier East) 22-15, Fr. (Dec 7-3)

9th Place Match

Cayden Alejos (Cabell Midland) 23-14, Fr. over Chase Sizemore (Oak Hill) 13-10, Fr. (Fall 4:14)

11th Place Match

Brody Bryner (Preston Hs) 11-14, So. over Ava Lemasters (Cameron) 9-9, Jr. (DFF)

13th Place Match

Payton Holstein (Oak Hill) 13-8, Fr. over Aaron Braun (Morgantown) 6-16, Fr. (TF-1.5 3:27 (17-1))

15th Place Match

Brady Davis (Morgantown) 2-12, So. over Ellie Juarez (North Marion) 8-18, Fr. (M. For.)

Guaranteed Places

- 1st Place - Ian Cornett of Buckhannon-Upshur
- 2nd Place - Triston Wills of Fairmont Senior
- 3rd Place - LJ Anderson of Cabell Midland
- 4th Place - Floyd Huff of Waynesburg Central Hs
- 5th Place - Owen Anderson of George Washington School
- 6th Place - Trevor Morgan of Huntington
- 7th Place - Kaleb Barbero of Woodrow Wilson
- 8th Place - Kirclyn Coleman of Oak Hill
- 9th Place - Jameson Hare of Morgantown
- 10th Place - Jake Kilkenny of Preston Hs
- 11th Place - Brice Shultz of Waynesburg Central Hs
- 12th Place - Liam Hartley of East Fairmont Hs
- 13th Place - Hayden Carpenter of North Marion

1st Place Match

Ian Cornett (Buckhannon-Upshur) 24-5, Sr. over Triston Wills (Fairmont Senior) 17-8, Sr. (Fall 3:44)

3rd Place Match

LJ Anderson (Cabell Midland) 24-6, So. over Floyd Huff (Waynesburg Central Hs) 10-10, Jr. (For.)

5th Place Match

Owen Anderson (George Washington School) 25-8, Jr. over Trevor Morgan (Huntington) 16-10, So. (Fall 4:15)

7th Place Match

Kaleb Barbero (Woodrow Wilson) 17-16, Fr. over Kirclyn Coleman (Oak Hill) 15-4, Jr. (Fall 0:51)

9th Place Match

Jameson Hare (Morgantown) 21-9, So. over Jake Kilkenny (Preston Hs) 4-8, Fr. (Fall 3:36)

11th Place Match

Brice Shultz (Waynesburg Central Hs) 4-13, Fr. over Liam Hartley (East Fairmont Hs) 6-16, Fr. (Fall 2:04)

13th Place Match

Hayden Carpenter (North Marion) 8-21, So. over () , . (Bye)

15th Place Match

() , . over () , . (Bye)

Guaranteed Places

- 1st Place - Ben Barrett of Huntington
- 2nd Place - Garrett Johnson of Woodrow Wilson
- 3rd Place - Colston Skeen of Parkersburg
- 4th Place - Levi Jennings of Preston Hs
- 5th Place - CJ Carrodus of Parkersburg
- 6th Place - Xaden Willett of East Fairmont Hs
- 7th Place - Issac Davis of Oak Hill
- 8th Place - Hayden Bonar of Cameron
- 9th Place - Clifton Shreves of Morgantown
- 10th Place - Cohen Prouse of Cabell Midland
- 11th Place - Knash Davis of George Washington School
- 12th Place - Jesse Huff of Waynesburg Central Hs
- 13th Place - Brayden Gorby of Fairmont Senior

1st Place Match

Ben Barrett (Huntington) 25-1, Jr. over Garrett Johnson (Woodrow Wilson) 16-4, Sr. (Dec 6-1)

3rd Place Match

Colston Skeen (Parkersburg) 18-6, Fr. over Levi Jennings (Preston Hs) 20-7, So. (TF-1.5 3:10 (16-1))

5th Place Match

CJ Carrodus (Parkersburg) 20-9, Jr. over Xaden Willett (East Fairmont Hs) 6-4, Sr. (MD 13-0)

7th Place Match

Issac Davis (Oak Hill) 23-9, So. over Hayden Bonar (Cameron) 10-8, So. (MD 16-5)

9th Place Match

Clifton Shreves (Morgantown) 14-13, Jr. over Cohen Prouse (Cabell Midland) 16-12, Fr. (Dec 6-2)

11th Place Match

Knash Davis (George Washington School) 3-5, Sr. over Jesse Huff (Waynesburg Central Hs) 5-11, So. (M. For.)

13th Place Match

Brayden Gorby (Fairmont Senior) 5-11, Jr. over () , . (Bye)

15th Place Match

() , . over () , . (Bye)

Guaranteed Places

- 1st Place - Stephen Myers of Parkersburg
- 2nd Place - Noah Hess of North Marion
- 3rd Place - Shad Henry of Huntington
- 4th Place - Jacob Meadows of Woodrow Wilson
- 5th Place - Aiden Fleshmen of Greenbrier East
- 6th Place - Bellanco Anthony of Cameron
- 7th Place - Parker Hale of Greenbrier East
- 8th Place - Porter Cole of Parkersburg
- 9th Place - Ryan Shreves of Morgantown
- 10th Place - Noah Shafer of Preston Hs
- 11th Place - Cale Winters of Cameron
- 12th Place - Atley Bonar of Cameron
- 13th Place - William Kennedy of Buckhannon-Upshur
- 14th Place - Will Pancake of North Marion
- 15th Place - Gavin Floyd of East Fairmont Hs
- 16th Place - Chase Adkins of Cabell Midland
- 17th Place - Max Wagner of Fairmont Senior
- 18th Place - Emerson Williams of Waynesburg Central Hs

1st Place Match

Stephen Myers (Parkersburg) 27-6, So. over Noah Hess (North Marion) 26-2, Sr. (Dec 12-6)

3rd Place Match

Shad Henry (Huntington) 22-6, Fr. over Jacob Meadows (Woodrow Wilson) 29-8, Sr. (Fall 2:48)

5th Place Match

Aiden Fleshmen (Greenbrier East) 31-9, Sr. over Bellanco Anthony (Cameron) 15-10, Fr. (Dec 1-0)

7th Place Match

Parker Hale (Greenbrier East) 27-13, Sr. over Porter Cole (Parkersburg) 16-10, So. (Fall 1:24)

9th Place Match

Ryan Shreves (Morgantown) 20-12, Fr. over Noah Shafer (Preston Hs) 14-13, Sr. (Dec 12-7)

11th Place Match

Cale Winters (Cameron) 5-8, Fr. over Atley Bonar (Cameron) 10-12, Sr. (MD 22-14)

13th Place Match

William Kennedy (Buckhannon-Upshur) 8-17, Fr. over Will Pancake (North Marion) 2-9, Jr. (Dec 5-2)

15th Place Match

Gavin Floyd (East Fairmont Hs) 4-16, Jr. over Chase Adkins (Cabell Midland) 5-15, Jr. (For.)

17th Place Match

Max Wagner (Fairmont Senior) 1-15, So. over Emerson Williams (Waynesburg Central Hs) 4-21, So. (For.)

19th Place Match

() , . over () , . (Bye)

Guaranteed Places

- 1st Place - Dominic Way of Parkersburg
- 2nd Place - Ben McComas of George Washington School
- 3rd Place - William Godby of Greenbrier East
- 4th Place - Andrew McDowell of Buckhannon-Upshur
- 5th Place - Landon Osborne of Woodrow Wilson
- 6th Place - Marshall Crow of Cameron
- 7th Place - Isaac Wiseman of Cabell Midland
- 8th Place - Owen Woodrum of Huntington
- 9th Place - Brayden Leffingwell of Cabell Midland
- 10th Place - Thad Tennant of North Marion
- 11th Place - Hayden Lantz of Preston Hs
- 12th Place - Bryce Swann of Fairmont Senior
- 13th Place - Cole Phillips of Waynesburg Central Hs
- 14th Place - Rocky Mazer of Oak Hill

1st Place Match

Dominic Way (Parkersburg) 27-4, So. over Ben McComas (George Washington School) 25-4, Sr. (Fall 0:53)

3rd Place Match

William Godby (Greenbrier East) 34-5, Sr. over Andrew McDowell (Buckhannon-Upshur) 19-5, Sr. (MD 10-0)

5th Place Match

Landon Osborne (Woodrow Wilson) 28-10, So. over Marshall Crow (Cameron) 11-8, So. (Fall 1:30)

7th Place Match

Isaac Wiseman (Cabell Midland) 7-3, Jr. over Owen Woodrum (Huntington) 14-12, So. (Fall 1:57)

9th Place Match

Brayden Leffingwell (Cabell Midland) 19-16, Jr. over Thad Tennant (North Marion) 12-16, Sr. (Fall 1:45)

11th Place Match

Hayden Lantz (Preston Hs) 12-12, So. over Bryce Swann (Fairmont Senior) 4-14, Jr. (Dec 8-5)

13th Place Match

Cole Phillips (Waynesburg Central Hs) 1-9, So. over Rocky Mazer (Oak Hill) 9-21, Fr. (MD 17-8)

15th Place Match

() , . over () , . (Bye)

Guaranteed Places

- 1st Place - Tyler Roark of Woodrow Wilson
- 2nd Place - Blake Ringer of East Fairmont Hs
- 3rd Place - Talen Brown of Cameron
- 4th Place - Kayden McDonald of Parkersburg
- 5th Place - Jason Walker of Fairmont Senior
- 6th Place - Jeff Hood of Huntington
- 7th Place - Eli Derr of George Washington School
- 8th Place - Carter Jones of Morgantown
- 9th Place - Dennis McCrary of Cabell Midland
- 10th Place - Alex Wamsley of Buckhannon-Upshur
- 11th Place - Sutton Bernet of North Marion
- 12th Place - Seth Adkins of Oak Hill
- 13th Place - Evan Currey of North Marion
- 14th Place - William Schmidle of Preston Hs
- 15th Place - Luke Rush of Waynesburg Central Hs

1st Place Match

Tyler Roark (Woodrow Wilson) 33-2, Sr. over Blake Ringer (East Fairmont Hs) 25-1, Jr. (Dec 6-2)

3rd Place Match

Talen Brown (Cameron) 23-4, Fr. over Kayden McDonald (Parkersburg) 25-9, So. (SV-1 8-5)

5th Place Match

Jason Walker (Fairmont Senior) 19-4, Jr. over Jeff Hood (Huntington) 20-8, Sr. (Fall 1:55)

7th Place Match

Eli Derr (George Washington School) 21-9, Jr. over Carter Jones (Morgantown) 25-10, Sr. (Dec 4-2)

9th Place Match

Dennis McCrary (Cabell Midland) 17-13, Jr. over Alex Wamsley (Buckhannon-Upshur) 18-13, Fr. (TF-1.5 1:35 (17-1))

11th Place Match

Sutton Bernet (North Marion) 6-9, Sr. over Seth Adkins (Oak Hill) 15-15, Fr. (Fall 2:16)

13th Place Match

Evan Currey (North Marion) 9-21, Sr. over William Schmidle (Preston Hs) 9-13, Jr. (Dec 5-2)

15th Place Match

Luke Rush (Waynesburg Central Hs) 8-11, Jr. over () , . (Bye)

Guaranteed Places

- 1st Place - Jimmie Bailes of Woodrow Wilson
- 2nd Place - Slayton Pettit of Cameron
- 3rd Place - Lars Cooper of Parkersburg
- 4th Place - Evan McDowell of Buckhannon-Upshur
- 5th Place - Jordan Murrell of Cabell Midland
- 6th Place - Ashton Walker of Waynesburg Central Hs
- 7th Place - Judah Moore of Huntington
- 8th Place - Dakota Parker of North Marion
- 9th Place - Saxon Elswick of George Washington School
- 10th Place - Dax Sunset of Fairmont Senior
- 11th Place - Trenton Rush of Preston Hs
- 12th Place - Randy Whyel of Waynesburg Central Hs
- 13th Place - Dylan Belt of Morgantown
- 14th Place - Gaven Petracca of East Fairmont Hs

1st Place Match

Jimmie Bailes (Woodrow Wilson) 30-2, Sr. over Slayton Pettit (Cameron) 16-1, Sr. (TF-1.5 3:12 (18-3))

3rd Place Match

Lars Cooper (Parkersburg) 15-5, So. over Evan McDowell (Buckhannon-Upshur) 15-9, Sr. (TF-1.5 3:49 (17-1))

5th Place Match

Jordan Murrell (Cabell Midland) 16-16, Fr. over Ashton Walker (Waynesburg Central Hs) 8-9, So. (Dec 6-3)

7th Place Match

Judah Moore (Huntington) 12-8, Fr. over Dakota Parker (North Marion) 9-22, Sr. (TF-1.5 3:00 (17-2))

9th Place Match

Saxon Elswick (George Washington School) 15-13, Fr. over Dax Sunset (Fairmont Senior) 5-14, Jr. (Fall 2:50)

11th Place Match

Trenton Rush (Preston Hs) 11-14, Jr. over Randy Whyel (Waynesburg Central Hs) 8-17, So. (For.)

13th Place Match

Dylan Belt (Morgantown) 11-18, So. over Gaven Petracca (East Fairmont Hs) 0-18, So. (Fall 0:38)

15th Place Match

() , . over () , . (Bye)

Guaranteed Places

- 1st Place - Maximus Fortier of Fairmont Senior
- 2nd Place - Solomon Truman of Oak Hill
- 3rd Place - Eli Tedrow of Cameron
- 4th Place - Dylan Bryant of Woodrow Wilson
- 5th Place - Lucas Marsh of East Fairmont Hs
- 6th Place - Parker Woods of Parkersburg
- 7th Place - Mason Miller of Greenbrier East
- 8th Place - Brayden Miller of Preston Hs
- 9th Place - Stephen Jones of Cabell Midland
- 10th Place - Zach Estep of Morgantown
- 11th Place - Avery Totten of George Washington School
- 12th Place - Jordan Wagner of Fairmont Senior
- 13th Place - JD Baker of North Marion
- 14th Place - Tucker Mason of Buckhannon-Upshur
- 15th Place - Kyran Fry of Buckhannon-Upshur

1st Place Match

Maximus Fortier (Fairmont Senior) 13-0, So. over Solomon Truman (Oak Hill) 33-3, Fr. (Dec 5-2)

3rd Place Match

Eli Tedrow (Cameron) 26-3, So. over Dylan Bryant (Woodrow Wilson) 23-16, Sr. (TF-1.5 1:50 (15-0))

5th Place Match

Lucas Marsh (East Fairmont Hs) 13-6, Sr. over Parker Woods (Parkersburg) 16-10, Fr. (M. For.)

7th Place Match

Mason Miller (Greenbrier East) 29-10, Fr. over Brayden Miller (Preston Hs) 18-9, So. (Fall 3:48)

9th Place Match

Stephen Jones (Cabell Midland) 17-16, So. over Zach Estep (Morgantown) 13-9, So. (Dec 6-1)

11th Place Match

Avery Totten (George Washington School) 17-14, Sr. over Jordan Wagner (Fairmont Senior) 4-14, Sr. (Dec 8-3)

13th Place Match

JD Baker (North Marion) 12-17, Fr. over Tucker Mason (Buckhannon-Upshur) 3-22, Fr. (Dec 9-4)

15th Place Match

Kyran Fry (Buckhannon-Upshur) 0-8, Fr. over () , . (Bye)

Guaranteed Places

- 1st Place - Vance Neal of Woodrow Wilson
- 2nd Place - Percie Hatfield of Cabell Midland
- 3rd Place - Jesse Showalter of Parkersburg
- 4th Place - Dominick Smith of Morgantown
- 5th Place - Griffen Miller of Cameron
- 6th Place - Noah Green of George Washington School
- 7th Place - Gavin Bowman of Parkersburg
- 8th Place - Rudy Carrillo of Fairmont Senior
- 9th Place - Chance Morgan of Buckhannon-Upshur
- 10th Place - Caleb Dobbins of Preston Hs
- 11th Place - Nathaniel Blankenship of Parkersburg
- 12th Place - Aiden Pester of Waynesburg Central Hs
- 13th Place - Ricky Wright of North Marion
- 14th Place - Greyson Bonar of Cameron
- 15th Place - Kevin Browning of Parkersburg

1st Place Match

Vance Neal (Woodrow Wilson) 27-4, Sr. over Percie Hatfield (Cabell Midland) 29-1, Sr. (SV-1 5-2)

3rd Place Match

Jesse Showalter (Parkersburg) 19-11, Sr. over Dominick Smith (Morgantown) 27-8, Sr. (Fall 2:44)

5th Place Match

Griffen Miller (Cameron) 16-5, Fr. over Noah Green (George Washington School) 18-8, Sr. (Dec 5-0)

7th Place Match

Gavin Bowman (Parkersburg) 11-7, Fr. over Rudy Carrillo (Fairmont Senior) 4-7, So. (Fall 1:52)

9th Place Match

Chance Morgan (Buckhannon-Upshur) 13-12, So. over Caleb Dobbins (Preston Hs) 3-6, So. (Fall 0:46)

11th Place Match

Nathaniel Blankenship (Parkersburg) 7-10, Jr. over Aiden Pester (Waynesburg Central Hs) 7-9, Sr. (M. For.)

13th Place Match

Ricky Wright (North Marion) 4-19, Jr. over Greyson Bonar (Cameron) 2-14, Fr. (Dec 10-5)

15th Place Match

Kevin Browning (Parkersburg) 3-9, Fr. over () , . (Bye)

Guaranteed Places

- 1st Place - Rowan Dunham of Huntington
- 2nd Place - Cole Turner of Preston Hs
- 3rd Place - Carson Kohl of Cabell Midland
- 4th Place - Klypsan Wallace of Cameron
- 5th Place - Louis Diaz of East Fairmont Hs
- 6th Place - Cyler Marks of Parkersburg
- 7th Place - Mason Haney of Morgantown
- 8th Place - Ky-Mani Sumpter of Waynesburg Central Hs
- 9th Place - Nick Dvorak of Woodrow Wilson
- 10th Place - Antonio Sellaro of Morgantown
- 11th Place - Brayden Stephens of Parkersburg
- 12th Place - Collin Andis of Morgantown
- 13th Place - Dominic Castillo of Buckhannon-Upshur
- 14th Place - Alex Newbold of Morgantown
- 15th Place - Dawson Hill of Cameron

1st Place Match

Rowan Dunham (Huntington) 19-5, So. over Cole Turner (Preston Hs) 24-4, Sr. (Dec 7-0)

3rd Place Match

Carson Kohl (Cabell Midland) 29-1, Jr. over Klypsan Wallace (Cameron) 6-0, Sr. (M. For.)

5th Place Match

Louis Diaz (East Fairmont Hs) 19-6, So. over Cyler Marks (Parkersburg) 18-13, Sr. (Fall 1:23)

7th Place Match

Mason Haney (Morgantown) 22-10, Sr. over Ky-Mani Sumpter (Waynesburg Central Hs) 12-11, So. (Fall 0:25)

9th Place Match

Nick Dvorak (Woodrow Wilson) 20-16, Sr. over Antonio Sellaro (Morgantown) 16-15, Jr. (Fall 1:38)

11th Place Match

Brayden Stephens (Parkersburg) 9-9, Sr. over Collin Andis (Morgantown) 1-9, So. (For.)

13th Place Match

Dominic Castillo (Buckhannon-Upshur) 2-7, Jr. over Alex Newbold (Morgantown) 3-11, Sr. (For.)

15th Place Match

Dawson Hill (Cameron) 1-14, Fr. over () , . (Bye)

Guaranteed Places

- 1st Place - Jacob Reeves of Woodrow Wilson
- 2nd Place - Braxton Johnson of Cabell Midland
- 3rd Place - Keshawn Bland of Greenbrier East
- 4th Place - Sam Klimas of Preston Hs
- 5th Place - Jeremiah Thompson of Buckhannon-Upshur
- 6th Place - Akeem Bivens of Parkersburg
- 7th Place - Jack Gorrell of George Washington School
- 8th Place - Parker Bigelow of Fairmont Senior
- 9th Place - Grant Robinson of Morgantown
- 10th Place - Gary Rader of East Fairmont Hs
- 11th Place - Fynn Wolfrum of Oak Hill
- 12th Place - Kaiden Chapmen of Cameron
- 13th Place - Brady Ford of Huntington
- 14th Place - Dibyes Poudel of Morgantown
- 15th Place - Robert White of North Marion

1st Place Match

Jacob Reeves (Woodrow Wilson) 31-7, Sr. over Braxton Johnson (Cabell Midland) 29-3, So. (SV-1 4-1)

3rd Place Match

Keshawn Bland (Greenbrier East) 28-9, So. over Sam Klimas (Preston Hs) 19-7, Sr. (MD 10-0)

5th Place Match

Jeremiah Thompson (Buckhannon-Upshur) 18-8, Sr. over Akeem Bivens (Parkersburg) 19-13, Jr. (Fall 4:54)

7th Place Match

Jack Gorrell (George Washington School) 16-11, Sr. over Parker Bigelow (Fairmont Senior) 9-12, So. (Fall 3:41)

9th Place Match

Grant Robinson (Morgantown) 13-10, Fr. over Gary Rader (East Fairmont Hs) 10-13, Jr. (MD 15-2)

11th Place Match

Fynn Wolfrum (Oak Hill) 16-17, Jr. over Kaiden Chapmen (Cameron) 9-11, Fr. (M. For.)

13th Place Match

Brady Ford (Huntington) 2-6, Fr. over Dibyes Poudel (Morgantown) 3-10, Jr. (M. For.)

15th Place Match

Robert White (North Marion) 5-6, Sr. over () , . (Bye)

Guaranteed Places

1st Place - Kyle Beverly of George Washington School

2nd Place - Landon Jones of Woodrow Wilson

3rd Place - Blake Jennings of Preston Hs

4th Place - Chase Travis of Morgantown

5th Place - Harrison Smith of Greenbrier East

6th Place - Zachariah Medina of Parkersburg

7th Place - Luke Colombo of Parkersburg

8th Place - Alex Walraven of Huntington

9th Place - Kevin Ramsey of North Marion

10th Place - Cameron Vangilder of East Fairmont Hs

11th Place - Aiden Robinson of Oak Hill

12th Place - Connor McKim of Buckhannon-Upshur

13th Place - Hunter Bocook of Huntington

14th Place - Marshall Holland of Cameron

15th Place - Josh Holden of North Marion

16th Place - Thomas Dequasie of Fairmont Senior

17th Place - Roger Trader of Fairmont Senior

1st Place Match

Kyle Beverly (George Washington School) 30-2, Sr. over Landon Jones (Woodrow Wilson) 7-1, Sr. (Dec 7-0)

3rd Place Match

Blake Jennings (Preston Hs) 25-4, So. over Chase Travis (Morgantown) 31-6, So. (Dec 5-1)

5th Place Match

Harrison Smith (Greenbrier East) 26-12, So. over Zachariah Medina (Parkersburg) 14-5, So. (MD 19-7)

7th Place Match

Luke Colombo (Parkersburg) 13-10, So. over Alex Walraven (Huntington) 19-15, Sr. (Fall 1:24)

9th Place Match

Kevin Ramsey (North Marion) 16-10, Sr. over Cameron Vangilder (East Fairmont Hs) 5-12, Jr. (Fall 1:12)

11th Place Match

Aiden Robinson (Oak Hill) 27-10, Fr. over Connor McKim (Buckhannon-Upshur) 14-11, Jr. (For.)

13th Place Match

Hunter Bocook (Huntington) 10-14, So. over Marshall Holland (Cameron) 6-12, So. (For.)

15th Place Match

Josh Holden (North Marion) 4-12, Jr. over Thomas Dequasie (Fairmont Senior) 4-14, Jr. (Fall 2:50)

17th Place Match

Roger Trader (Fairmont Senior) 0-12, Jr. over () , . (Bye)

19th Place Match

() , . over () , . (Bye)

Guaranteed Places

- 1st Place - James Payne of George Washington School
- 2nd Place - King Abercrombie of Fairmont Senior
- 3rd Place - Dylan Apanowicz of Fairmont Senior
- 4th Place - Brad Edens of Cabell Midland
- 5th Place - Zuvon Shipman of Morgantown
- 6th Place - Levi Yost-Lewellen of Waynesburg Central Hs
- 7th Place - Tamarion West of Woodrow Wilson
- 8th Place - Hunter Rogers of North Marion
- 9th Place - Lincoln Fisher of Waynesburg Central Hs
- 10th Place - Hayden Cole of Preston Hs
- 11th Place - TC Vaughn of Huntington
- 12th Place - Mathew Hawkins of Buckhannon-Upshur

1st Place Match

James Payne (George Washington School) 29-5, So. over King Abercrombie (Fairmont Senior) 10-6, So. (Fall 5:59)

3rd Place Match

Dylan Apanowicz (Fairmont Senior) 17-6, So. over Brad Edens (Cabell Midland) 24-10, Jr. (SV-1 7-4)

5th Place Match

Zuvon Shipman (Morgantown) 24-8, Jr. over Levi Yost-Lewellen (Waynesburg Central Hs) 7-10, So. (TB-1 5-1)

7th Place Match

Tamarion West (Woodrow Wilson) 14-21, Fr. over Hunter Rogers (North Marion) 16-10, Jr. (For.)

9th Place Match

Lincoln Fisher (Waynesburg Central Hs) 8-9, Fr. over Hayden Cole (Preston Hs) 11-10, So. (Fall 2:51)

11th Place Match

TC Vaughn (Huntington) 1-6, Fr. over Mathew Hawkins (Buckhannon-Upshur) 7-16, Fr. (Fall 0:42)

Winner`s Choice

POOL A		Round 1	Round 2	Round 3	Round 4	Round 5
1	S. Drennen, PHS	2 / Bout _ Drennen Bye	3 / Bout 1171 Drennen Fall 2:13	4 / Bout 1261 Drennen Fall 0:53	5 / Bout 1351 Drennen For.	6 / Bout 1441 Drennen Fall 4:46
2	Bye	1 / Bout _ Drennen Bye	5 / Bout _ Linko Bye	6 / Bout _ Asano Bye	4 / Bout _ Lilly Bye	3 / Bout _ Ward Bye
3	A. Ward, CAMI	4 / Bout 1081 Ward Fall 4:00	1 / Bout 1171 Drennen Fall 2:13	5 / Bout 1262 Linko TF-1.5 4:28 (16-1)	6 / Bout 1352 Asano Dec 3-0	2 / Bout _ Ward Bye
4	L. Lilly, PRHS	3 / Bout 1081 Ward Fall 4:00	6 / Bout 1172 Asano Fall 2:28	1 / Bout 1261 Drennen Fall 0:53	2 / Bout _ Lilly Bye	5 / Bout 1442 Linko Fall 2:36
5	A. Linko, PHS	6 / Bout 1082 Linko TF-1.5 5:47 (16-1)	2 / Bout _ Linko Bye	3 / Bout 1262 Linko TF-1.5 4:28 (16-1)	1 / Bout 1351 Drennen For.	4 / Bout 1442 Linko Fall 2:36
6	K. Asano, GREA	5 / Bout 1082 Linko TF-1.5 5:47 (16-1)	4 / Bout 1172 Asano Fall 2:28	2 / Bout _ Asano Bye	3 / Bout 1352 Asano Dec 3-0	1 / Bout 1441 Drennen Fall 4:46

POOL B		Round 1	Round 2	Round 3	Round 4	Round 5
1	B. Simmons, CAMI	2 / Bout _ Simmons Bye	3 / Bout 1173 Simmons Fall 1:40	4 / Bout 1263 Simmons Fall 1:39	5 / Bout 1353 Simmons Fall 2:30	6 / Bout 1443 Simmons Dec 7-4
2	Bye	1 / Bout _ Simmons Bye	5 / Bout _ Brand Bye	6 / Bout _ Jones Bye	4 / Bout _ Lilley Bye	3 / Bout _ Hamilton Bye
3	K. Hamilton, EFH	4 / Bout 1083 Lilley Fall 0:57	1 / Bout 1173 Simmons Fall 1:40	5 / Bout 1264 Brand Dec 5-2	6 / Bout 1354 Jones Fall 2:53	2 / Bout _ Hamilton Bye
4	M. Lilley, CAME	3 / Bout 1083 Lilley Fall 0:57	6 / Bout 1174 Jones Fall 5:04	1 / Bout 1263 Simmons Fall 1:39	2 / Bout _ Lilley Bye	5 / Bout 1444 Lilley Dec 4-0
5	K. Brand, FASE	6 / Bout 1084 Jones Fall 3:25	2 / Bout _ Brand Bye	3 / Bout 1264 Brand Dec 5-2	1 / Bout 1353 Simmons Fall 2:30	4 / Bout 1444 Lilley Dec 4-0
6	B. Jones, WOWI	5 / Bout 1084 Jones Fall 3:25	4 / Bout 1174 Jones Fall 5:04	2 / Bout _ Jones Bye	3 / Bout 1354 Jones Fall 2:53	1 / Bout 1443 Simmons Dec 7-4

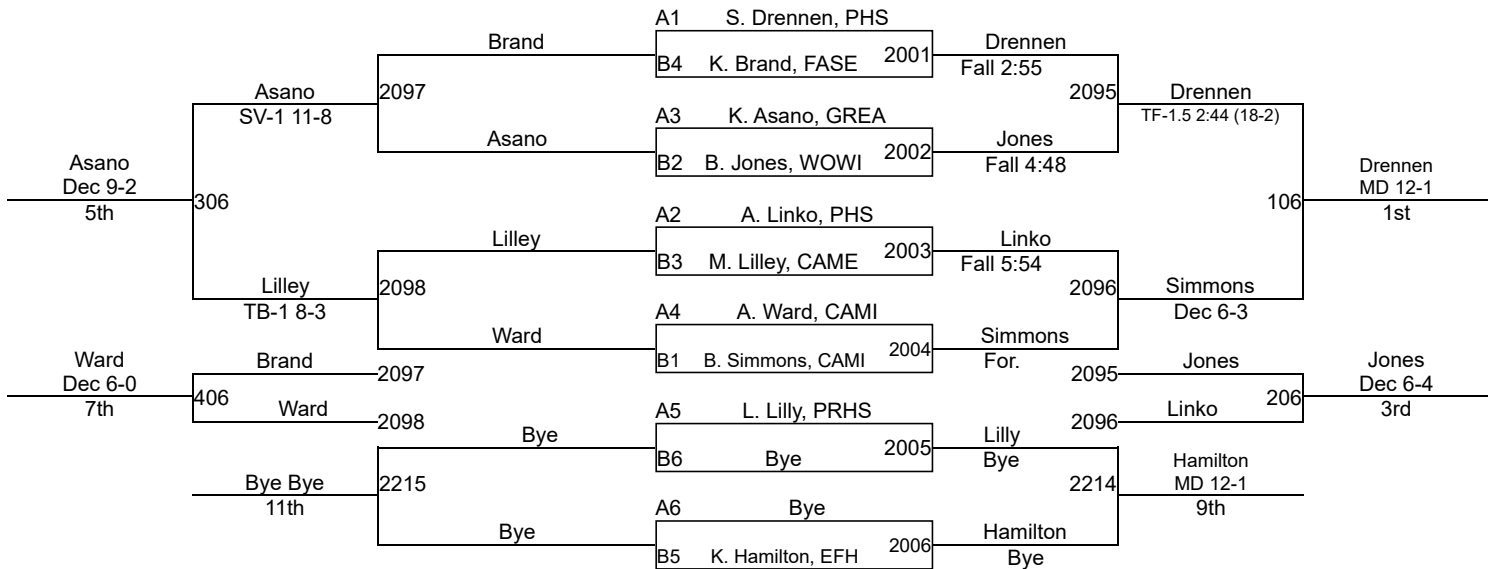

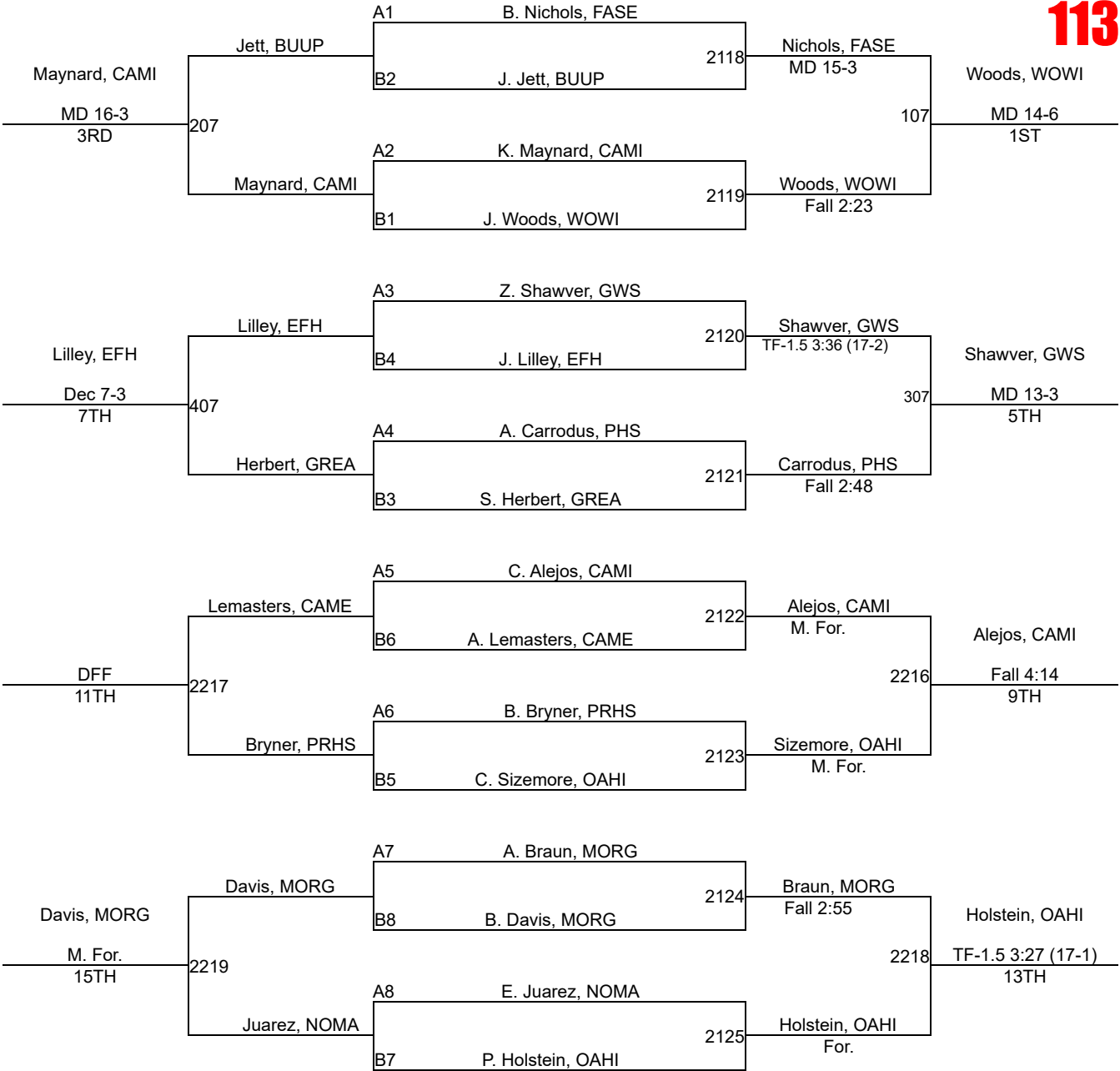

Round 1

Nichols, FASE
Alejos, CAMI 1016
Nichols, FASE
TF-1.5 2:23 (17-0)

Shawver, GWS
Carrodus, PHS 1017
Shawver, GWS
Dec 12-8

Maynard, CAMI
Juarez, NOMA 1018
Maynard, CAMI
Fall 0:17

Bryner, PRHS
Braun, MORG 1019
Bryner, PRHS
Fall 1:19

Round 2

Nichols, FASE
Bryner, PRHS 1106
Nichols, FASE
Fall 1:39

Shawver, GWS
Alejos, CAMI 1107
Shawver, GWS
TF-1.5 2:22 (17-2)

Maynard, CAMI
Braun, MORG 1108
Maynard, CAMI
Fall 0:32

Carrodus, PHS
Juarez, NOMA 1109
Carrodus, PHS
TF-1.5 2:40 (17-1)

Round 3

Nichols, FASE
Carrodus, PHS 1196
Nichols, FASE
MD 13-5

Shawver, GWS
Maynard, CAMI 1197
Maynard, CAMI
Fall 3:29

Alejos, CAMI
Braun, MORG 1198
Alejos, CAMI
TF-1.5 3:56 (19-4)

Bryner, PRHS
Juarez, NOMA 1199
Bryner, PRHS
Fall 0:52

Round 4

Nichols, FASE
Juarez, NOMA 1286
Nichols, FASE
Fall 0:40

Shawver, GWS
Bryner, PRHS 1287
Shawver, GWS
Fall 1:23

Maynard, CAMI
Alejos, CAMI 1288
Maynard, CAMI
For.

Carrodus, PHS
Braun, MORG 1289
Carrodus, PHS
Fall 1:43

Round 5

Nichols, FASE
Maynard, CAMI 1376
Nichols, FASE
Dec 7-2

Shawver, GWS
Braun, MORG 1377
Shawver, GWS
Fall 0:47

Carrodus, PHS
Bryner, PRHS 1378
Carrodus, PHS
TF-1.5 3:51 (15-0)

Alejos, CAMI
Juarez, NOMA 1379
Alejos, CAMI
Fall 0:36

Round 6

Nichols, FASE
Braun, MORG 1466
Nichols, FASE
Fall 0:24

Shawver, GWS
Juarez, NOMA 1467
Shawver, GWS
Fall 0:28

Maynard, CAMI
Bryner, PRHS 1468
Maynard, CAMI
Fall 1:29

Carrodus, PHS
Alejos, CAMI 1469
Carrodus, PHS
TF-1.5 4:54 (17-2)

Round 7

Nichols, FASE
Shawver, GWS 2028
Nichols, FASE
TF-1.5 2:36 (21-4)

Maynard, CAMI
Carrodus, PHS 2029
Carrodus, PHS
Dec 10-4

Alejos, CAMI
Bryner, PRHS 2030
Alejos, CAMI
Fall 2:44

Juarez, NOMA
Braun, MORG 2031
Braun, MORG
For.

Round 1

Woods, WOWI
Holstein, OAH
1020
Woods, WOWI
Fall 0:40

Jett, BUUP
Herbert, GRE
1021
Jett, BUUP
Fall 3:49

Sizemore, OAH
Lilley, EFH
1022
Lilley, EFH
Dec 8-3

Lemasters, CAME
Davis, MORG
1023
Lemasters, CAME
Fall 2:29

Round 2

Woods, WOWI
Lemasters, CAME
1110
Woods, WOWI
Fall 0:39

Jett, BUUP
Holstein, OAH
1111
Jett, BUUP
Fall 0:24

Sizemore, OAH
Davis, MORG
1112
Sizemore, OAH
Fall 0:44

Herbert, GRE
Lilley, EFH
1113
Herbert, GRE
Fall 3:48

Round 3

Woods, WOWI
Herbert, GRE
1200
Woods, WOWI
Fall 1:56

Jett, BUUP
Sizemore, OAH
1201
Jett, BUUP
Fall 1:20

Holstein, OAH
Davis, MORG
1202
Holstein, OAH
Fall 0:59

Lemasters, CAME
Lilley, EFH
1203
Lilley, EFH
MD 14-2

Round 4

Woods, WOWI
Lilley, EFH
1290
Woods, WOWI
Fall 4:14

Jett, BUUP
Lemasters, CAME
1291
Jett, BUUP
Fall 1:10

Sizemore, OAH
Holstein, OAH
1292
Sizemore, OAH
Fall 2:41

Herbert, GRE
Davis, MORG
1293
Herbert, GRE
Fall 2:40

Round 5

Woods, WOWI
Sizemore, OAH
1380
Woods, WOWI
Fall 0:55

Jett, BUUP
Davis, MORG
1381
Jett, BUUP
Fall 0:12

Herbert, GRE
Lemasters, CAME
1382
Herbert, GRE
M. For.

Holstein, OAH
Lilley, EFH
1383
Lilley, EFH
Fall 5:12

Round 6

Woods, WOWI
Davis, MORG
1470
Woods, WOWI
Fall 0:44

Jett, BUUP
Lilley, EFH
1471
Jett, BUUP
Fall 2:13

Sizemore, OAH
Lemasters, CAME
1472
Sizemore, OAH
M. For.

Herbert, GRE
Holstein, OAH
1473
Herbert, GRE
Fall 0:46

Round 7

Woods, WOWI
Jett, BUUP
2032
Woods, WOWI
Fall 3:08

Sizemore, OAH
Herbert, GRE
2033
Herbert, GRE
Fall 3:19

Holstein, OAH
Lemasters, CAME
2034
Lemasters, CAME
M. For.

Lilley, EFH
Davis, MORG
2035
Lilley, EFH
Fall 1:43

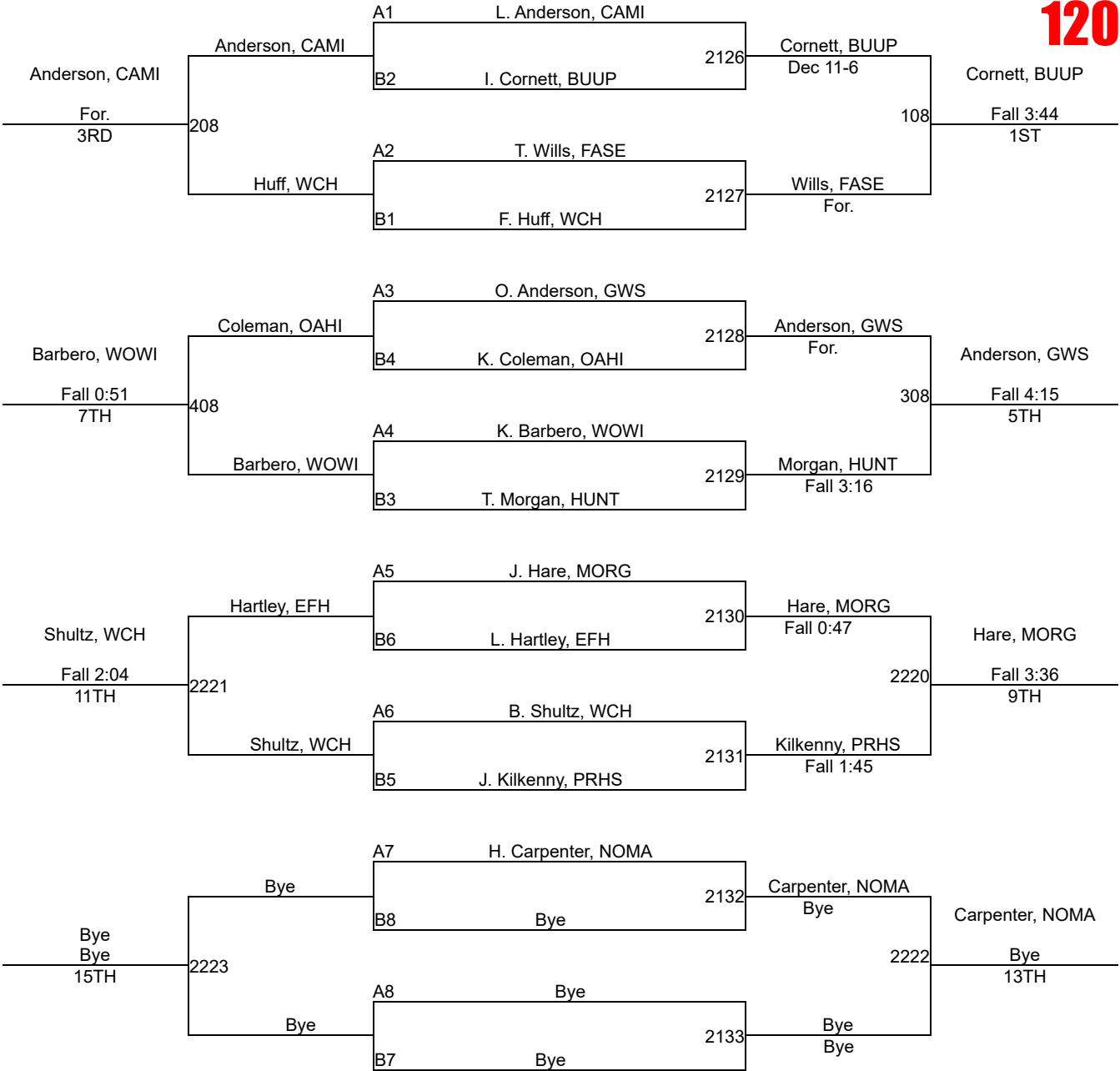

Round 1

Wills, FASE
Barbero, WOWI
1024
Wills, FASE
Fall 1:21

Anderson, GWS
Hare, MORG
1025
Anderson, GWS
TF-1.5 4:33 (19-3)

Anderson, CAMI
Shultz, WCH
1026
Anderson, CAMI
Fall 3:30

Carpenter, NOMA
Bye
Carpenter, NOMA
Bye

Round 2

Wills, FASE
Carpenter, NOMA
1114
Wills, FASE
Fall 0:38

Anderson, GWS
Barbero, WOWI
1115
Anderson, GWS
Fall 1:58

Anderson, CAMI
Bye
Anderson, CAMI
Bye

Hare, MORG
Shultz, WCH
1116
Hare, MORG
Fall 4:40

Round 3

Wills, FASE
Hare, MORG
1204
Wills, FASE
MD 13-2

Anderson, GWS
Anderson, CAMI
1205
Anderson, CAMI
Fall 5:41

Barbero, WOWI
Bye
Barbero, WOWI
Bye

Carpenter, NOMA
Shultz, WCH
1206
Shultz, WCH
Fall 0:54

Round 4

Wills, FASE
Shultz, WCH
1294
Wills, FASE
Fall 0:14

Anderson, GWS
Carpenter, NOMA
1295
Anderson, GWS
Fall 2:13

Anderson, CAMI
Barbero, WOWI
1296
Anderson, CAMI
Fall 2:53

Hare, MORG
Bye
Hare, MORG
Bye

Round 5

Wills, FASE
Anderson, CAMI
1384
Anderson, CAMI
MD 11-1

Anderson, GWS
Bye
Anderson, GWS
Bye

Hare, MORG
Carpenter, NOMA
1385
Hare, MORG
Fall 0:51

Barbero, WOWI
Shultz, WCH
1386
Barbero, WOWI
Fall 0:41

Round 6

Wills, FASE
Bye
Wills, FASE
Bye

Anderson, GWS
Shultz, WCH
1474
Anderson, GWS
Fall 0:31

Anderson, CAMI
Carpenter, NOMA
1475
Anderson, CAMI
Fall 0:22

Hare, MORG
Barbero, WOWI
1476
Barbero, WOWI
TF-1.5 3:23 (18-0)

Round 7

Wills, FASE
Anderson, GWS
2036
Wills, FASE
Fall 3:29

Anderson, CAMI
Hare, MORG
2037
Anderson, CAMI
Fall 1:05

Barbero, WOWI
Carpenter, NOMA
2038
Barbero, WOWI
Fall 0:50

Shultz, WCH
Bye
Shultz, WCH
Bye

Round 1

Cornett, BUUP
Hartley, EFH 1027
Cornett, BUUP
Fall 0:40

Morgan, HUNT
Coleman, OAHl 1028
Morgan, HUNT
TF-1.5 2:23 (15-0)

Huff, WCH
Bye
Huff, WCH
Bye

Kilkenny, PRHS
Bye
Kilkenny, PRHS
Bye

Round 2

Cornett, BUUP
Kilkenny, PRHS 1117
Cornett, BUUP
Fall 0:45

Morgan, HUNT
Hartley, EFH 1118
Morgan, HUNT
Fall 0:06

Huff, WCH
Bye
Huff, WCH
Bye

Coleman, OAHl
Bye
Coleman, OAHl
Bye

Round 3

Cornett, BUUP
Coleman, OAHl 1207
Cornett, BUUP
Fall 0:33

Morgan, HUNT
Huff, WCH 1208
Huff, WCH
Dec 13-10

Hartley, EFH
Bye
Hartley, EFH
Bye

Kilkenny, PRHS
Bye
Kilkenny, PRHS
Bye

Round 4

Cornett, BUUP
Bye
Cornett, BUUP
Bye

Morgan, HUNT
Kilkenny, PRHS 1297
Morgan, HUNT
Fall 0:30

Huff, WCH
Hartley, EFH 1298
Huff, WCH
Fall 0:41

Coleman, OAHl
Bye
Coleman, OAHl
Bye

Round 5

Cornett, BUUP
Huff, WCH 1387
Huff, WCH
MD 18-4

Morgan, HUNT
Bye
Morgan, HUNT
Bye

Coleman, OAHl
Kilkenny, PRHS 1388
Coleman, OAHl
Fall 3:29

Hartley, EFH
Bye
Hartley, EFH
Bye

Round 6

Cornett, BUUP
Bye
Cornett, BUUP
Bye

Morgan, HUNT
Bye
Morgan, HUNT
Bye

Huff, WCH
Kilkenny, PRHS 1477
Huff, WCH
TF-1.5 2:00 (16-0)

Coleman, OAHl
Hartley, EFH 1478
Coleman, OAHl
Fall 2:16

Round 7

Cornett, BUUP
Morgan, HUNT 2039
Cornett, BUUP
TF-1.5 5:30 (19-2)

Huff, WCH
Coleman, OAHl 2040
Coleman, OAHl
For.

Hartley, EFH
Kilkenny, PRHS 2041
Kilkenny, PRHS
Fall 0:46

Bye
Bye
Bye
Bye



Round 1

Johnson, WOWI
Bonar, CAME
1029
Johnson, WOWI
Fall 0:42

Skeen, PHS
Davis, GWS
1030
Skeen, PHS
TF-1.5 2:18 (18-2)

Carrodus, PHS
Huff, WCH
1031
Carrodus, PHS
TF-1.5 3:59 (16-1)

Gorby, FASE
Bye
Gorby, FASE
Bye

Round 2

Johnson, WOWI
Gorby, FASE
1119
Johnson, WOWI
Fall 1:07

Skeen, PHS
Bonar, CAME
1120
Skeen, PHS
Fall 1:10

Carrodus, PHS
Bye
Carrodus, PHS
Bye

Davis, GWS
Huff, WCH
1121
Davis, GWS
Fall 0:40

Round 3

Johnson, WOWI
Davis, GWS
1209
Johnson, WOWI
Fall 1:00

Skeen, PHS
Carrodus, PHS
1210
Skeen, PHS
For.

Bonar, CAME
Bye
Bonar, CAME
Bye

Gorby, FASE
Huff, WCH
1211
Huff, WCH
Fall 1:09

Round 4

Johnson, WOWI
Huff, WCH
1299
Johnson, WOWI
Fall 1:13

Skeen, PHS
Gorby, FASE
1300
Skeen, PHS
Fall 0:40

Carrodus, PHS
Bonar, CAME
1301
Carrodus, PHS
Fall 3:20

Davis, GWS
Bye
Davis, GWS
Bye

Round 5

Johnson, WOWI
Carrodus, PHS
1389
Johnson, WOWI
Dec 4-3

Skeen, PHS
Bye
Skeen, PHS
Bye

Davis, GWS
Gorby, FASE
1390
Davis, GWS
Fall 3:17

Bonar, CAME
Huff, WCH
1391
Bonar, CAME
Fall 5:42

Round 6

Johnson, WOWI
Bye
Johnson, WOWI
Bye

Skeen, PHS
Huff, WCH
1479
Skeen, PHS
M. For.

Carrodus, PHS
Gorby, FASE
1480
Carrodus, PHS
Fall 0:21

Davis, GWS
Bonar, CAME
1481
Bonar, CAME
Fall 2:41

Round 7

Johnson, WOWI
Skeen, PHS
2042
Johnson, WOWI
MD 10-0

Carrodus, PHS
Davis, GWS
2043
Carrodus, PHS
Fall 1:13

Bonar, CAME
Gorby, FASE
2044
Bonar, CAME
Fall 4:39

Huff, WCH
Bye
Huff, WCH
Bye

Round 1

Barrett, HUNT	Willett, EFH	Davis, OAH	Shreves, MORG
Prouse, CAMI 1032	Jennings, PRHS 1033	Davis, OAH	Shreves, MORG
Barrett, HUNT TF-1.5 3:04 (20-2)	Jennings, PRHS Dec 11-9	Bye	Bye

Round 2

Barrett, HUNT	Willett, EFH	Davis, OAH	Jennings, PRHS
Shreves, MORG 1122	Prouse, CAMI 1123	Bye	Bye
Barrett, HUNT Fall 1:31	Willett, EFH Fall 1:12	Davis, OAH	Jennings, PRHS

Round 3

Barrett, HUNT	Willett, EFH	Prouse, CAMI	Shreves, MORG
Jennings, PRHS 1212	Davis, OAH 1213	Bye	Bye
Barrett, HUNT TF-1.5 4:51 (17-1)	Willett, EFH Fall 1:24	Prouse, CAMI	Shreves, MORG

Round 4

Barrett, HUNT	Willett, EFH	Davis, OAH	Jennings, PRHS
Bye	Shreves, MORG 1302	Prouse, CAMI 1303	Bye
Barrett, HUNT	Willett, EFH TF-1.5 4:14 (16-0)	Davis, OAH	Jennings, PRHS

Round 5

Barrett, HUNT	Willett, EFH	Jennings, PRHS	Prouse, CAMI
Davis, OAH 1392	Bye	Shreves, MORG 1393	Bye
Barrett, HUNT Fall 3:06	Willett, EFH	Jennings, PRHS Fall 2:20	Prouse, CAMI

Round 6

Barrett, HUNT	Willett, EFH	Davis, OAH	Jennings, PRHS
Bye	Bye	Shreves, MORG 1482	Prouse, CAMI 1483
Barrett, HUNT	Willett, EFH	Davis, OAH TF-1.5 3:15 (17-2)	Jennings, PRHS

Round 7

Barrett, HUNT	Davis, OAH	Prouse, CAMI	Bye
Willett, EFH 2045	Jennings, PRHS 2046	Shreves, MORG 2047	Bye
Barrett, HUNT TF-1.5 3:03 (17-2)	Jennings, PRHS Fall 3:11	Prouse, CAMI Dec 13-7	Bye

Winner`s Choice

132

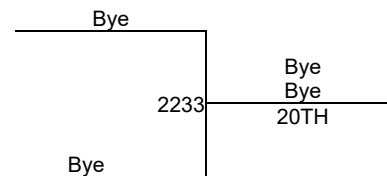
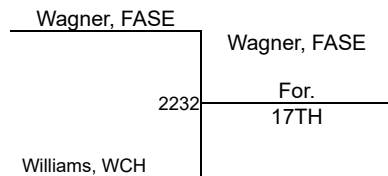
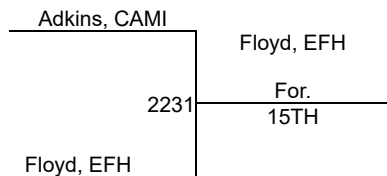
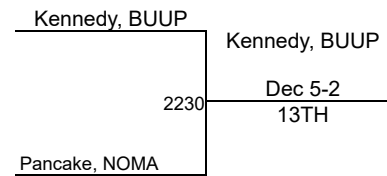
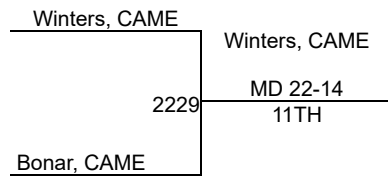
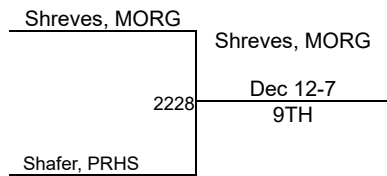
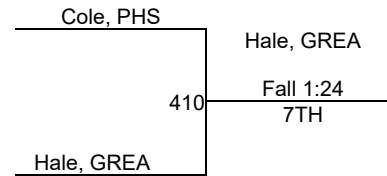
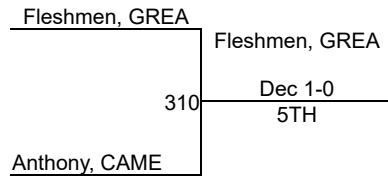
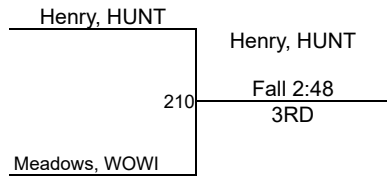
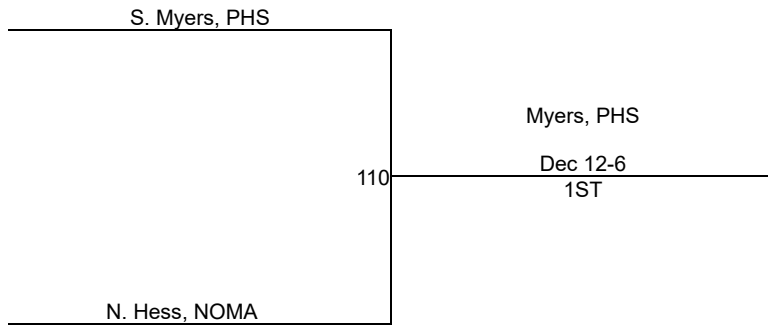

Round 1

Myers, PHS
Henry, HUNT 1001
Myers, PHS
Fall 1:49

Cole, PHS
Bye
Cole, PHS
Bye

Kennedy, BUUP
Fleshmen, GREA 1002
Fall 1:31

Winters, CAME
Shreves, MORG 1003
Fall 2:50

Wagner, FASE
Adkins, CAMI 1004
Fall 1:34

Round 2

Myers, PHS
Winters, CAME 1091
Myers, PHS
Fall 1:23

Henry, HUNT
Kennedy, BUUP 1092
Henry, HUNT
Fall 0:59

Cole, PHS
Wagner, FASE 1093
Cole, PHS
Fall 1:24

Adkins, CAMI
Fleshmen, GREA 1094
Fall 1:19

Shreves, MORG
Bye
Shreves, MORG
Bye

Round 3

Myers, PHS
Shreves, MORG 1181
Myers, PHS
Fall 0:20

Henry, HUNT
Adkins, CAMI 1182
Henry, HUNT
Fall 0:48

Cole, PHS
Fleshmen, GREA 1183
Fall 1:04

Kennedy, BUUP
Winters, CAME 1184
Winters, CAME
MD 15-5

Wagner, FASE
Bye
Wagner, FASE
Bye

Round 4

Myers, PHS
Bye
Myers, PHS
Bye

Henry, HUNT
Cole, PHS 1271
Henry, HUNT
Fall 2:44

Kennedy, BUUP
Shreves, MORG 1272
Shreves, MORG
Fall 1:46

Winters, CAME
Adkins, CAMI 1273
Winters, CAME
Fall 1:58

Wagner, FASE
Fleshmen, GREA 1274
Fleshmen, GREA
Fall 0:39

Round 5

Myers, PHS
Kennedy, BUUP 1361
Myers, PHS
Fall 0:06

Henry, HUNT
Wagner, FASE 1362
Henry, HUNT
Fall 0:13

Cole, PHS
Winters, CAME 1363
Cole, PHS
TB-1 14-7

Adkins, CAMI
Shreves, MORG 1364
Shreves, MORG
Fall 1:01

Fleshmen, GREA
Bye
Fleshmen, GREA
Bye

Round 6

Myers, PHS
Adkins, CAMI 1451
Myers, PHS
Fall 1:28

Henry, HUNT
Fleshmen, GREA 1452
Henry, HUNT
TF-1.5 6:00 (22-6)

Cole, PHS
Shreves, MORG 1453
Cole, PHS
Dec 10-9

Kennedy, BUUP
Bye
Kennedy, BUUP
Bye

Winters, CAME
Wagner, FASE 1454
Winters, CAME
Fall 2:38

Round 7

Myers, PHS
Cole, PHS 2013
Myers, PHS
Fall 0:55

Henry, HUNT
Bye
Henry, HUNT
Bye

Kennedy, BUUP
Adkins, CAMI 2014
Kennedy, BUUP
Fall 1:15

Winters, CAME
Fleshmen, GREA 2015
Fall 0:38

Wagner, FASE
Shreves, MORG 2016
Shreves, MORG
Fall 1:05

Round 8

Myers, PHS
Wagner, FASE 2103
Myers, PHS
Fall 0:33

Henry, HUNT
Winters, CAME 2104
Henry, HUNT
Fall 1:32

Cole, PHS
Kennedy, BUUP 2105
Cole, PHS
Fall 3:17

Adkins, CAMI
Bye
Adkins, CAMI
Bye

Shreves, MORG
Fleshmen, GREA 2106
TF-1.5 4:00 (18-0)

Round 9

Myers, PHS
Fleshmen, GREA 2198
Myers, PHS
Fall 3:37

Henry, HUNT
Shreves, MORG 2199
Henry, HUNT
Fall 2:30

Cole, PHS
Adkins, CAMI 2200
Cole, PHS
For.

Kennedy, BUUP
Wagner, FASE 2201
Kennedy, BUUP
Fall 1:08

Winters, CAME
Bye
Winters, CAME
Bye

Round 1

Hess, NOMA
Hale, GREA 1005
Hess, NOMA TF-1.5 4:00 (19-2)

Shafer, PRHS
Bye
Shafer, PRHS
Bye

Williams, WCH
Meadows, WOWI 1006
Meadows, WOWI Fall 0:58

Pancake, NOMA
Anthony, CAME 1007
Anthony, CAME Fall 1:27

Floyd, EFH
Bonar, CAME 1008
Bonar, CAME Fall 1:55

Round 2

Hess, NOMA
Pancake, NOMA 1095
Hess, NOMA Fall 1:13

Hale, GREA
Williams, WCH 1096
Hale, GREA Fall 0:41

Shafer, PRHS
Floyd, EFH 1097
Shafer, PRHS TF-1.5 1:26 (16-0)

Bonar, CAME
Meadows, WOWI 1098
Meadows, WOWI Fall 0:42

Anthony, CAME
Bye
Anthony, CAME
Bye

Round 3

Hess, NOMA
Anthony, CAME 1185
Hess, NOMA MD 14-1

Hale, GREA
Bonar, CAME 1186
Hale, GREA Dec 8-4

Shafer, PRHS
Meadows, WOWI 1187
Meadows, WOWI Fall 1:56

Williams, WCH
Pancake, NOMA 1188
Pancake, NOMA Dec 12-6

Floyd, EFH
Bye
Floyd, EFH
Bye

Round 4

Hess, NOMA
Bye
Hess, NOMA
Bye

Hale, GREA
Shafer, PRHS 1275
Hale, GREA Fall 5:33

Williams, WCH
Anthony, CAME 1276
Anthony, CAME Fall 0:42

Pancake, NOMA
Bonar, CAME 1277
Bonar, CAME Fall 0:52

Floyd, EFH
Meadows, WOWI 1278
Meadows, WOWI Fall 0:19

Round 5

Hess, NOMA
Williams, WCH 1365
Hess, NOMA TF-1.5 1:39 (17-1)

Hale, GREA
Floyd, EFH 1366
Hale, GREA Fall 0:52

Shafer, PRHS
Pancake, NOMA 1367
Shafer, PRHS TF-1.5 3:09 (16-0)

Bonar, CAME
Anthony, CAME 1368
Anthony, CAME Dec 9-7

Meadows, WOWI
Bye
Meadows, WOWI
Bye

Round 6

Hess, NOMA
Bonar, CAME 1455
Hess, NOMA Fall 2:53

Hale, GREA
Meadows, WOWI 1456
Hale, GREA TF-1.5 3:05 (18-2)

Shafer, PRHS
Anthony, CAME 1457
Anthony, CAME Fall 3:10

Williams, WCH
Bye
Williams, WCH
Bye

Pancake, NOMA
Floyd, EFH 1458
Pancake, NOMA Dec 6-0

Round 7

Hess, NOMA
Shafer, PRHS 2017
Hess, NOMA Fall 1:17

Hale, GREA
Bye
Hale, GREA
Bye

Williams, WCH
Bonar, CAME 2018
Bonar, CAME For.

Pancake, NOMA
Meadows, WOWI 2019
Meadows, WOWI Fall 1:22

Floyd, EFH
Anthony, CAME 2020
Anthony, CAME Fall 1:01

Round 8

Hess, NOMA
Floyd, EFH 2107
Hess, NOMA TF-1.5 1:24 (15-0)

Hale, GREA
Pancake, NOMA 2108
Hale, GREA Fall 0:34

Shafer, PRHS
Williams, WCH 2109
Shafer, PRHS For.

Bonar, CAME
Bye
Bonar, CAME
Bye

Anthony, CAME
Meadows, WOWI 2110
Meadows, WOWI MD 19-10

Round 9

Hess, NOMA
Meadows, WOWI 2202
Hess, NOMA Dec 10-4

Hale, GREA
Anthony, CAME 2203
Anthony, CAME Dec 8-7

Shafer, PRHS
Bonar, CAME 2204
Shafer, PRHS Fall 3:14

Williams, WCH
Floyd, EFH 2205
Floyd, EFH For.

Pancake, NOMA
Bye
Pancake, NOMA
Bye

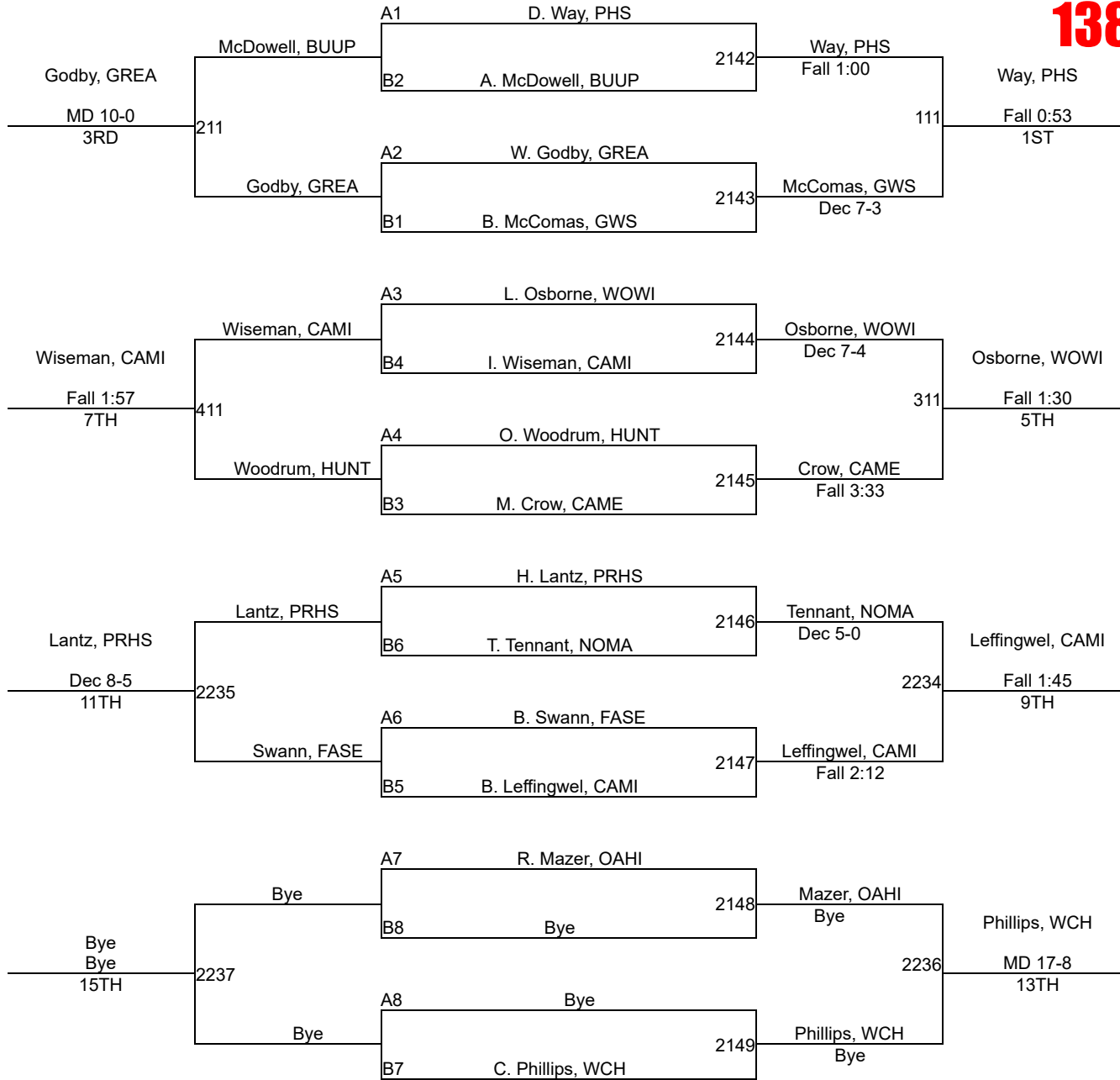

Round 1

Way, PHS
Lantz, PRHS 1034
Way, PHS TF-1.5 2:49 (16-1)

Godby, GREA
Woodrum, HUNT 1035
Godby, GREA TF-1.5 4:29 (18-3)

Osborne, WOWI
Swann, FASE 1036
Osborne, WOWI Fall 2:00

Mazer, OAH1
Bye
Mazer, OAH1 Bye

Round 2

Way, PHS
Mazer, OAH1 1124
Way, PHS Fall 1:18

Godby, GREA
Lantz, PRHS 1125
Godby, GREA Fall 1:50

Osborne, WOWI
Bye
Osborne, WOWI Bye

Woodrum, HUNT
Swann, FASE 1126
Woodrum, HUNT Fall 1:06

Round 3

Way, PHS
Woodrum, HUNT 1214
Way, PHS Fall 0:28

Godby, GREA
Osborne, WOWI 1215
Godby, GREA MD 11-2

Lantz, PRHS
Bye
Lantz, PRHS Bye

Mazer, OAH1
Swann, FASE 1216
Swann, FASE TF-1.5 2:00 (18-3)

Round 4

Way, PHS
Swann, FASE 1304
Way, PHS Fall 1:32

Godby, GREA
Mazer, OAH1 1305
Godby, GREA Fall 1:11

Osborne, WOWI
Lantz, PRHS 1306
Osborne, WOWI MD 10-2

Woodrum, HUNT
Bye
Woodrum, HUNT Bye

Round 5

Way, PHS
Osborne, WOWI 1394
Way, PHS Fall 1:54

Godby, GREA
Bye
Godby, GREA Bye

Woodrum, HUNT
Mazer, OAH1 1395
Woodrum, HUNT Fall 1:02

Lantz, PRHS
Swann, FASE 1396
Lantz, PRHS MD 22-12

Round 6

Way, PHS
Bye
Way, PHS Bye

Godby, GREA
Swann, FASE 1484
Godby, GREA Fall 0:58

Osborne, WOWI
Mazer, OAH1 1485
Osborne, WOWI Fall 0:38

Woodrum, HUNT
Lantz, PRHS 1486
Woodrum, HUNT Fall 3:38

Round 7

Way, PHS
Godby, GREA 2048
Way, PHS Fall 2:50

Osborne, WOWI
Woodrum, HUNT 2049
Osborne, WOWI TF-1.5 5:27 (16-0)

Lantz, PRHS
Mazer, OAH1 2050
Lantz, PRHS Dec 11-5

Swann, FASE
Bye
Swann, FASE Bye

Round 1

McComas, GWS
Crow, CAME 1037
McComas, GWS
Fall 2:33

McDowell, BUUP
Leffingwel, CAMI 1038
McDowell, BUUP
Fall 3:20

Wiseman, CAMI
Phillips, WCH 1039
Wiseman, CAMI
Fall 1:46

Tennant, NOMA
Bye
Tennant, NOMA
Bye

Round 2

McComas, GWS
Tennant, NOMA 1127
McComas, GWS
TF-1.5 2:19 (22-4)

McDowell, BUUP
Crow, CAME 1128
McDowell, BUUP
Fall 2:06

Wiseman, CAMI
Bye
Wiseman, CAMI
Bye

Leffingwel, CAMI
Phillips, WCH 1129
Leffingwel, CAMI
Fall 0:29

Round 3

McComas, GWS
Leffingwel, CAMI 1217
McComas, GWS
Fall 2:47

McDowell, BUUP
Wiseman, CAMI 1218
Wiseman, CAMI
Dec 9-5

Crow, CAME
Bye
Crow, CAME
Bye

Tennant, NOMA
Phillips, WCH 1219
Tennant, NOMA
TF-1.5 4:51 (16-0)

Round 4

McComas, GWS
Phillips, WCH 1307
McComas, GWS
Fall 1:43

McDowell, BUUP
Tennant, NOMA 1308
McDowell, BUUP
Fall 0:26

Wiseman, CAMI
Crow, CAME 1309
Crow, CAME
Dec 6-5

Leffingwel, CAMI
Bye
Leffingwel, CAMI
Bye

Round 5

McComas, GWS
Wiseman, CAMI 1397
McComas, GWS
TF-1.5 4:26 (18-2)

McDowell, BUUP
Bye
McDowell, BUUP
Bye

Leffingwel, CAMI
Tennant, NOMA 1398
Leffingwel, CAMI
Fall 0:31

Crow, CAME
Phillips, WCH 1399
Crow, CAME
Fall 1:23

Round 6

McComas, GWS
Bye
McComas, GWS
Bye

McDowell, BUUP
Phillips, WCH 1487
McDowell, BUUP
Fall 0:43

Wiseman, CAMI
Tennant, NOMA 1488
Wiseman, CAMI
Fall 1:04

Leffingwel, CAMI
Crow, CAME 1489
Crow, CAME
TF-1.5 6:00 (24-7)

Round 7

McComas, GWS
McDowell, BUUP 2051
McComas, GWS
MD 12-3

Wiseman, CAMI
Leffingwel, CAMI 2052
Wiseman, CAMI
Dec 11-5

Crow, CAME
Tennant, NOMA 2053
Crow, CAME
Fall 0:29

Phillips, WCH
Bye
Phillips, WCH
Bye

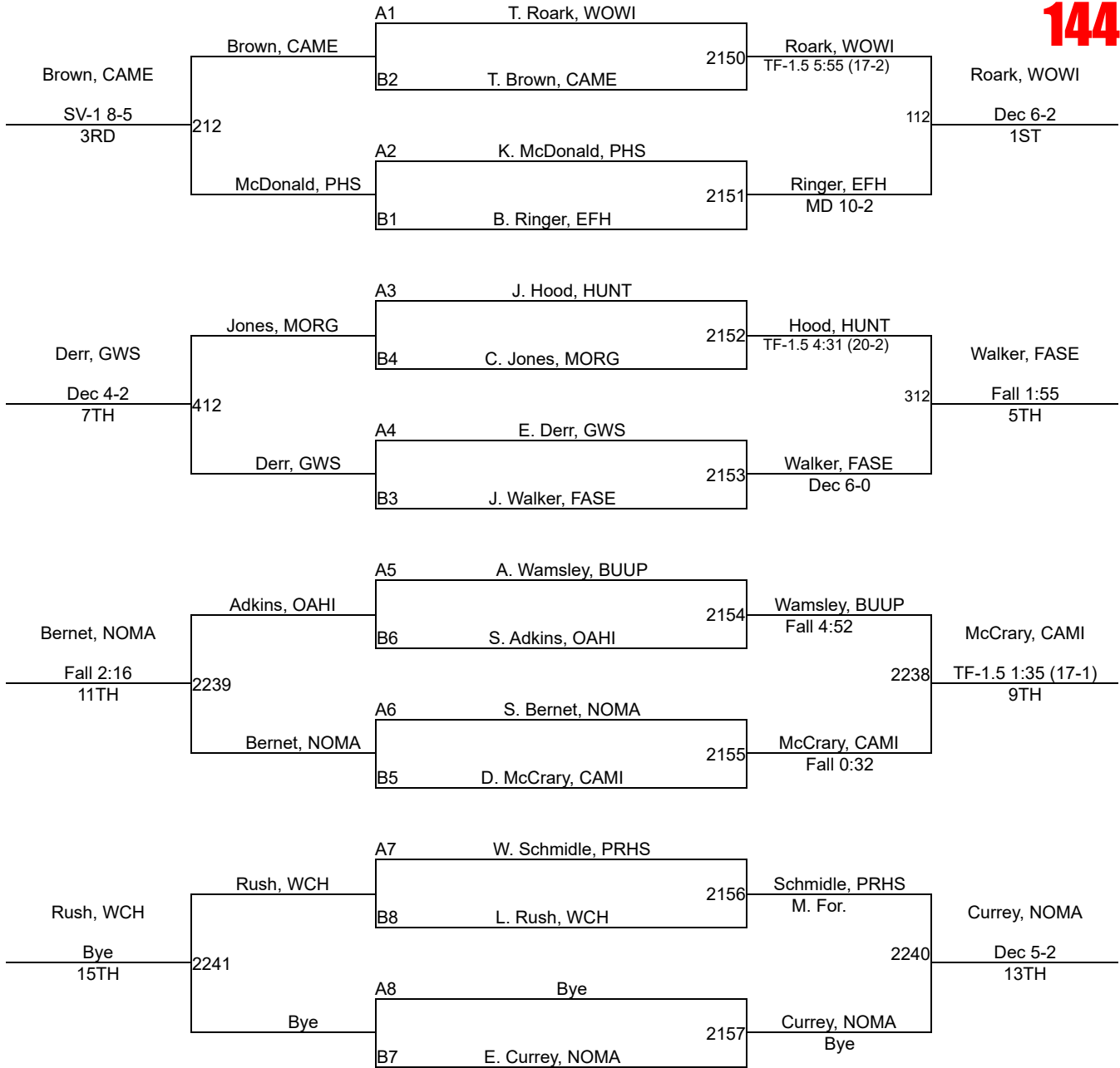

Round 1

Roark, WOWI
Wamsley, BUUP
1040
Roark, WOWI
Fall 1:40

McDonald, PHS
1041
McDonald, PHS
Fall 5:03
Derr, GWS

Hood, HUNT
1042
Hood, HUNT
Fall 2:00
Bernet, NOMA

Schmidle, PRHS
Schmidle, PRHS
Bye

Round 2

Roark, WOWI
Schmidle, PRHS
1130
Roark, WOWI
Fall 1:04

McDonald, PHS
1131
McDonald, PHS
TF-1.5 2:00 (15-0)
Wamsley, BUUP

Hood, HUNT
Bye
Hood, HUNT
Bye

Derr, GWS
1132
Derr, GWS
Fall 3:23
Bernet, NOMA

Round 3

Roark, WOWI
Derr, GWS
1220
Roark, WOWI
TF-1.5 2:00 (15-0)

McDonald, PHS
1221
McDonald, PHS
Dec 10-5
Hood, HUNT

Wamsley, BUUP
Bye
Wamsley, BUUP
Bye

Schmidle, PRHS
1222
Bernet, NOMA
Fall 5:18

Round 4

Roark, WOWI
Bernet, NOMA
1310
Roark, WOWI
Fall 0:44

McDonald, PHS
1311
McDonald, PHS
Fall 1:53
Schmidle, PRHS

Hood, HUNT
1312
Hood, HUNT
Fall 1:17
Wamsley, BUUP

Derr, GWS
Bye
Derr, GWS
Bye

Round 5

Roark, WOWI
Hood, HUNT
1400
Roark, WOWI
TF-1.5 3:08 (16-0)

McDonald, PHS
Bye
McDonald, PHS
Bye

Derr, GWS
1401
Derr, GWS
Fall 1:16
Schmidle, PRHS

Wamsley, BUUP
1402
Wamsley, BUUP
Fall 4:56
Bernet, NOMA

Round 6

Roark, WOWI
Bye
Roark, WOWI
Bye

McDonald, PHS
1490
McDonald, PHS
Fall 0:29
Bernet, NOMA

Hood, HUNT
1491
Hood, HUNT
Fall 0:30
Schmidle, PRHS

Derr, GWS
1492
Derr, GWS
Fall 0:58
Wamsley, BUUP

Round 7

Roark, WOWI
McDonald, PHS
2054
Roark, WOWI
TF-1.5 2:59 (16-0)

Hood, HUNT
2055
Hood, HUNT
Fall 3:51
Derr, GWS

Wamsley, BUUP
2056
Wamsley, BUUP
MD 9-1
Schmidle, PRHS

Bernet, NOMA
Bye
Bernet, NOMA
Bye

Round 1

Ringer, EFH
Adkins, OAH
1043
Ringer, EFH
Fall 2:27

Walker, FASE
Jones, MORG
1044
Walker, FASE
Fall 1:55

Brown, CAME
Rush, WCH
1045
Brown, CAME
TF-1.5 2:59 (15-0)

McCrary, CAMI
Currey, NOMA
1046
McCrary, CAMI
Fall 1:53

Round 2

Ringer, EFH
McCrary, CAMI
1133
Ringer, EFH
TF-1.5 3:06 (17-1)

Walker, FASE
Adkins, OAH
1134
Walker, FASE
Fall 0:53

Brown, CAME
Currey, NOMA
1135
Brown, CAME
Fall 0:55

Jones, MORG
Rush, WCH
1136
Jones, MORG
Fall 2:00

Round 3

Ringer, EFH
Jones, MORG
1223
Ringer, EFH
TF-1.5 3:28 (21-5)

Walker, FASE
Brown, CAME
1224
Brown, CAME
TB-1 4-3

Adkins, OAH
Currey, NOMA
1225
Adkins, OAH
Fall 2:59

McCrary, CAMI
Rush, WCH
1226
McCrary, CAMI
M. For.

Round 4

Ringer, EFH
Rush, WCH
1313
Ringer, EFH
M. For.

Walker, FASE
McCrary, CAMI
1314
Walker, FASE
Fall 4:35

Brown, CAME
Adkins, OAH
1315
Brown, CAME
Fall 1:28

Jones, MORG
Currey, NOMA
1316
Jones, MORG
TF-1.5 2:29 (17-1)

Round 5

Ringer, EFH
Brown, CAME
1403
Ringer, EFH
TF-1.5 3:31 (15-0)

Walker, FASE
Currey, NOMA
1404
Walker, FASE
TF-1.5 2:21 (16-0)

Jones, MORG
McCrary, CAMI
1405
Jones, MORG
MD 16-3

Adkins, OAH
Rush, WCH
1406
Adkins, OAH
M. For.

Round 6

Ringer, EFH
Currey, NOMA
1493
Ringer, EFH
Fall 1:51

Walker, FASE
Rush, WCH
1494
Walker, FASE
M. For.

Brown, CAME
McCrary, CAMI
1495
Brown, CAME
Fall 1:30

Jones, MORG
Adkins, OAH
1496
Jones, MORG
Fall 1:56

Round 7

Ringer, EFH
Walker, FASE
2057
Ringer, EFH
TF-1.5 5:38 (15-0)

Brown, CAME
Jones, MORG
2058
Brown, CAME
Fall 1:37

Adkins, OAH
McCrary, CAMI
2059
McCrary, CAMI
Fall 1:34

Rush, WCH
Currey, NOMA
2060
Currey, NOMA
M. For.

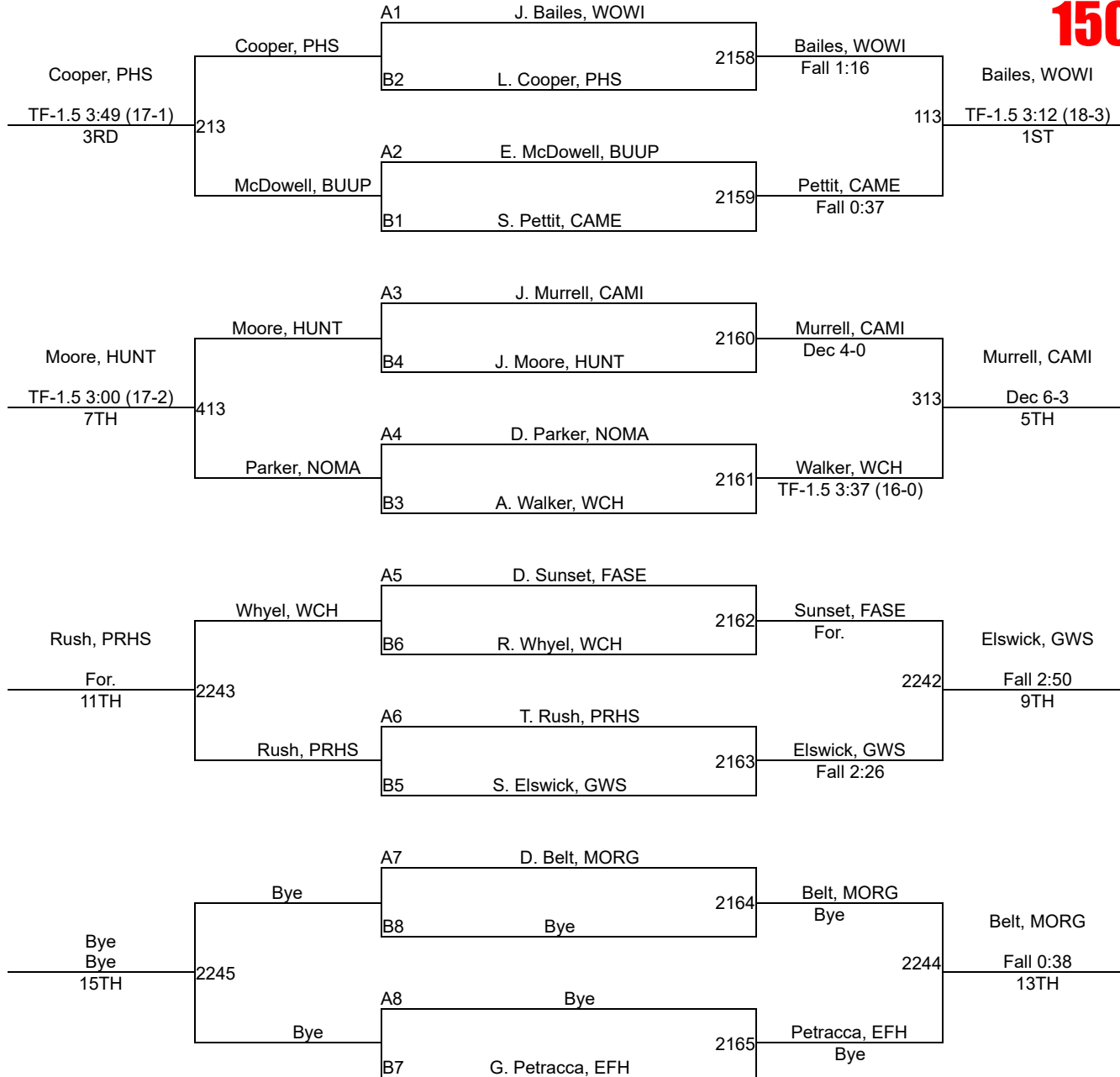

Round 1

Bailes, WOWI		McDowell, BUUP		Murrell, CAMI		Parker, NOMA	
Belt, MORG	1047	Rush, PRHS	1048	Sunset, FASE	1049	Bye	
Bailes, WOWI Fall 0:36		McDowell, BUUP Fall 0:46		Murrell, CAMI Fall 2:27		Parker, NOMA Bye	

Round 2

Bailes, WOWI		McDowell, BUUP		Murrell, CAMI		Rush, PRHS	
Parker, NOMA	1137	Belt, MORG	1138	Bye		Sunset, FASE	1139
Bailes, WOWI Fall 0:40		McDowell, BUUP Fall 1:03		Murrell, CAMI Bye		Sunset, FASE Fall 1:10	

Round 3

Bailes, WOWI		McDowell, BUUP		Belt, MORG		Parker, NOMA	
Rush, PRHS	1227	Murrell, CAMI	1228	Bye		Sunset, FASE	1229
Bailes, WOWI TF-1.5 1:15 (18-1)		McDowell, BUUP Fall 1:27		Belt, MORG Bye		Parker, NOMA Fall 3:31	

Round 4

Bailes, WOWI		McDowell, BUUP		Murrell, CAMI		Rush, PRHS	
Sunset, FASE	1317	Parker, NOMA	1318	Belt, MORG	1319	Bye	
Bailes, WOWI Fall 1:05		McDowell, BUUP Fall 1:19		Murrell, CAMI Fall 1:21		Rush, PRHS Bye	

Round 5

Bailes, WOWI		McDowell, BUUP		Rush, PRHS		Belt, MORG	
Murrell, CAMI	1407	Bye		Parker, NOMA	1408	Sunset, FASE	1409
Bailes, WOWI Fall 1:05		McDowell, BUUP Bye		Rush, PRHS TF-1.5 1:40 (18-1)		Sunset, FASE Fall 1:14	

Round 6

Bailes, WOWI		McDowell, BUUP		Murrell, CAMI		Rush, PRHS	
Bye		Sunset, FASE	1497	Parker, NOMA	1498	Belt, MORG	1499
Bailes, WOWI Bye		McDowell, BUUP Fall 1:35		Murrell, CAMI Fall 1:53		Rush, PRHS Fall 0:18	

Round 7

Bailes, WOWI		Murrell, CAMI		Belt, MORG		Sunset, FASE	
McDowell, BUUP	2061	Rush, PRHS	2062	Parker, NOMA	2063	Bye	
Bailes, WOWI TF-1.5 1:33 (19-3)		Murrell, CAMI Fall 3:36		Parker, NOMA Fall 2:49		Sunset, FASE Bye	

Round 1

Pettit, CAME	Cooper, PHS	Moore, HUNT	Walker, WCH
Whyel, WCH 1050	Elswick, GWS 1051	Petracca, EFH 1052	Bye
Pettit, CAME Fall 0:23	Cooper, PHS TF-1.5 4:48 (16-0)	Moore, HUNT Fall 1:06	Walker, WCH Bye

Round 2

Pettit, CAME	Cooper, PHS	Moore, HUNT	Elswick, GWS
Walker, WCH 1140	Whyel, WCH 1141	Bye	Petracca, EFH 1142
Pettit, CAME Fall 0:21	Cooper, PHS Fall 2:20	Moore, HUNT Bye	Elswick, GWS Fall 0:52

Round 3

Pettit, CAME	Cooper, PHS	Whyel, WCH	Walker, WCH
Elswick, GWS 1230	Moore, HUNT 1231	Bye	Petracca, EFH 1232
Pettit, CAME Fall 0:48	Cooper, PHS Fall 2:33	Whyel, WCH Bye	Walker, WCH Fall 3:29

Round 4

Pettit, CAME	Cooper, PHS	Moore, HUNT	Elswick, GWS
Petracca, EFH 1320	Walker, WCH 1321	Whyel, WCH 1322	Bye
Pettit, CAME Fall 0:11	Cooper, PHS Fall 1:12	Moore, HUNT Fall 3:36	Elswick, GWS Bye

Round 5

Pettit, CAME	Cooper, PHS	Elswick, GWS	Whyel, WCH
Moore, HUNT 1410	Bye	Walker, WCH 1411	Petracca, EFH 1412
Pettit, CAME Fall 0:57	Cooper, PHS Bye	Walker, WCH Dec 11-5	Whyel, WCH Fall 3:30

Round 6

Pettit, CAME	Cooper, PHS	Moore, HUNT	Elswick, GWS
Bye	Petracca, EFH 1500	Walker, WCH 1501	Whyel, WCH 1502
Pettit, CAME Bye	Cooper, PHS Fall 2:26	Walker, WCH MD 19-5	Elswick, GWS Dec 13-7

Round 7

Pettit, CAME	Moore, HUNT	Whyel, WCH	Petracca, EFH
Cooper, PHS 2064	Elswick, GWS 2065	Walker, WCH 2066	Bye
Pettit, CAME Fall 1:44	Moore, HUNT Dec 8-5	Walker, WCH For.	Petracca, EFH Bye

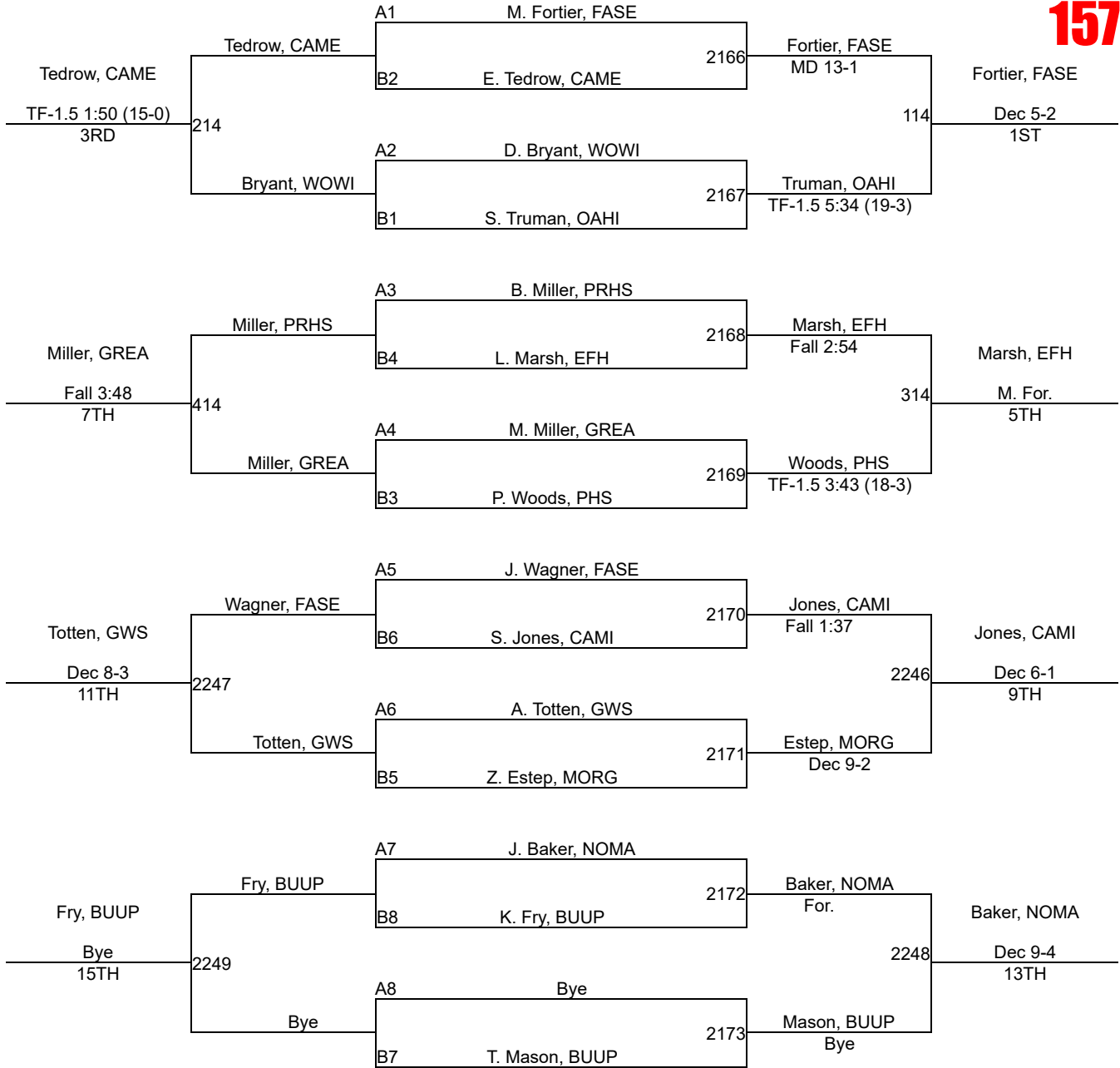

Round 1

Fortier, FASE
Bryant, WOWI
1053
Fortier, FASE
Fall 0:37

Miller, GREA
Totten, GWS
1054
Miller, GREA
Fall 4:56

Miller, PRHS
Wagner, FASE
1055
Miller, PRHS
Fall 1:55

Baker, NOMA
Bye
Baker, NOMA
Bye

Round 2

Fortier, FASE
Baker, NOMA
1143
Fortier, FASE
Fall 0:15

Miller, GREA
Bryant, WOWI
1144
Bryant, WOWI
Fall 0:27

Miller, PRHS
Bye
Miller, PRHS
Bye

Totten, GWS
Wagner, FASE
1145
Wagner, FASE
Fall 1:49

Round 3

Fortier, FASE
Totten, GWS
1233
Fortier, FASE
Fall 1:17

Miller, GREA
Miller, PRHS
1234
Miller, PRHS
MD 18-9

Bryant, WOWI
Bye
Bryant, WOWI
Bye

Baker, NOMA
Wagner, FASE
1235
Baker, NOMA
Dec 10-3

Round 4

Fortier, FASE
Wagner, FASE
1323
Fortier, FASE
For.

Miller, GREA
Baker, NOMA
1324
Miller, GREA
Fall 2:29

Miller, PRHS
Bryant, WOWI
1325
Bryant, WOWI
MD 19-11

Totten, GWS
Bye
Totten, GWS
Bye

Round 5

Fortier, FASE
Miller, PRHS
1413
Fortier, FASE
Fall 1:18

Miller, GREA
Bye
Miller, GREA
Bye

Totten, GWS
Baker, NOMA
1414
Totten, GWS
MD 15-2

Bryant, WOWI
Wagner, FASE
1415
Bryant, WOWI
Fall 2:25

Round 6

Fortier, FASE
Bye
Fortier, FASE
Bye

Miller, GREA
Wagner, FASE
1503
Miller, GREA
Fall 4:00

Miller, PRHS
Baker, NOMA
1504
Miller, PRHS
Fall 0:43

Totten, GWS
Bryant, WOWI
1505
Bryant, WOWI
Inj. 0:00

Round 7

Fortier, FASE
Miller, GREA
2067
Fortier, FASE
Fall 0:11

Miller, PRHS
Totten, GWS
2068
Miller, PRHS
Fall 3:07

Bryant, WOWI
Baker, NOMA
2069
Bryant, WOWI
Fall 1:25

Wagner, FASE
Bye
Wagner, FASE
Bye

Round 1

Tedrow, CAME
 Woods, PHS 1056
 Tedrow, CAME
 TF-1.5 4:17 (16-0)

Truman, OAH
 Estep, MORG 1057
 Truman, OAH
 Fall 4:10

Marsh, EFH
 Mason, BUUP 1058
 Marsh, EFH
 Fall 0:56

Jones, CAMI
 Fry, BUUP 1059
 Jones, CAMI
 Fall 0:39

Round 2

Tedrow, CAME
 Jones, CAMI 1146
 Tedrow, CAME
 Fall 1:19

Truman, OAH
 Woods, PHS 1147
 Truman, OAH
 TF-1.5 3:41 (17-1)

Marsh, EFH
 Fry, BUUP 1148
 Marsh, EFH
 Fall 3:27

Estep, MORG
 Mason, BUUP 1149
 Estep, MORG
 Fall 3:36

Round 3

Tedrow, CAME
 Estep, MORG 1236
 Tedrow, CAME
 Fall 0:47

Truman, OAH
 Marsh, EFH 1237
 Truman, OAH
 TF-1.5 4:36 (16-1)

Woods, PHS
 Fry, BUUP 1238
 Woods, PHS
 Fall 1:33

Jones, CAMI
 Mason, BUUP 1239
 Jones, CAMI
 Fall 0:43

Round 4

Tedrow, CAME
 Mason, BUUP 1326
 Tedrow, CAME
 TF-1.5 1:09 (15-0)

Truman, OAH
 Jones, CAMI 1327
 Truman, OAH
 Fall 1:10

Marsh, EFH
 Woods, PHS 1328
 Woods, PHS
 Dec 5-4

Estep, MORG
 Fry, BUUP 1329
 Estep, MORG
 Fall 3:34

Round 5

Tedrow, CAME
 Marsh, EFH 1416
 Tedrow, CAME
 Dec 3-0

Truman, OAH
 Fry, BUUP 1417
 Truman, OAH
 Fall 0:57

Estep, MORG
 Jones, CAMI 1418
 Estep, MORG
 Fall 5:46

Woods, PHS
 Mason, BUUP 1419
 Woods, PHS
 Fall 0:34

Round 6

Tedrow, CAME
 Fry, BUUP 1506
 Tedrow, CAME
 Fall 0:11

Truman, OAH
 Mason, BUUP 1507
 Truman, OAH
 Fall 1:45

Marsh, EFH
 Jones, CAMI 1508
 Marsh, EFH
 Fall 0:47

Estep, MORG
 Woods, PHS 1509
 Woods, PHS
 TF-1.5 4:30 (15-0)

Round 7

Tedrow, CAME
 Truman, OAH 2070
 Truman, OAH
 Dec 6-2

Marsh, EFH
 Estep, MORG 2071
 Marsh, EFH
 Dec 6-0

Woods, PHS
 Jones, CAMI 2072
 Woods, PHS
 Fall 3:11

Mason, BUUP
 Fry, BUUP 2073
 Mason, BUUP
 For.

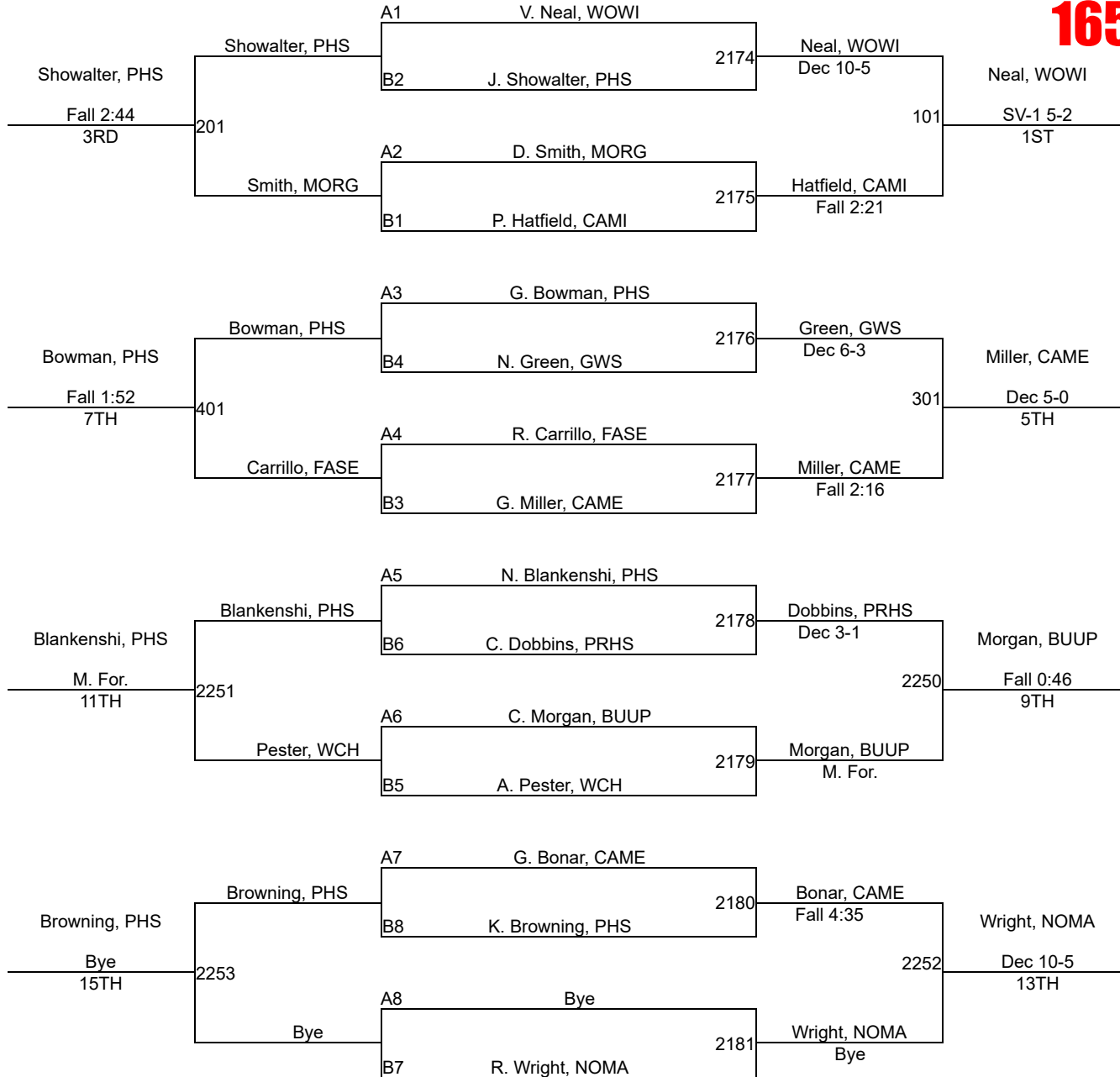

Round 1

Neal, WOWI
Morgan, BUUP 1060
Neal, WOWI TF-1.5 3:29 (20-2)

Smith, MORG
Bowman, PHS 1061
Smith, MORG MD 15-3

Carrillo, FASE
Bonar, CAME 1062
Carrillo, FASE Fall 0:28

Blankenshi, PHS
Blankenshi, PHS
Bye

Round 2

Neal, WOWI
Blankenshi, PHS 1150
Neal, WOWI Fall 1:41

Smith, MORG
Morgan, BUUP 1151
Smith, MORG MD 13-3

Carrillo, FASE
Bye
Carrillo, FASE Bye

Bowman, PHS
Bonar, CAME 1152
Bowman, PHS Fall 1:32

Round 3

Neal, WOWI
Bowman, PHS 1240
Neal, WOWI TF-1.5 3:32 (18-1)

Smith, MORG
Carrillo, FASE 1241
Smith, MORG Fall 3:56

Morgan, BUUP
Bye
Morgan, BUUP Bye

Blankenshi, PHS
Bonar, CAME 1242
Blankenshi, PHS Fall 2:00

Round 4

Neal, WOWI
Bonar, CAME 1330
Neal, WOWI Fall 1:46

Smith, MORG
Blankenshi, PHS 1331
Smith, MORG Fall 0:49

Carrillo, FASE
Morgan, BUUP 1332
Carrillo, FASE Fall 0:40

Bowman, PHS
Bye
Bowman, PHS Bye

Round 5

Neal, WOWI
Carrillo, FASE 1420
Neal, WOWI MD 14-5

Smith, MORG
Bye
Smith, MORG Bye

Bowman, PHS
Blankenshi, PHS 1421
Bowman, PHS Fall 1:36

Morgan, BUUP
Bonar, CAME 1422
Morgan, BUUP Fall 1:14

Round 6

Neal, WOWI
Bye
Neal, WOWI Bye

Smith, MORG
Bonar, CAME 1510
Smith, MORG Fall 0:19

Carrillo, FASE
Blankenshi, PHS 1511
Carrillo, FASE Fall 1:13

Bowman, PHS
Morgan, BUUP 1512
Bowman, PHS MD 10-2

Round 7

Neal, WOWI
Smith, MORG 2074
Neal, WOWI Fall 0:41

Carrillo, FASE
Bowman, PHS 2075
Bowman, PHS Fall 5:13

Morgan, BUUP
Blankenshi, PHS 2076
Blankenshi, PHS Dec 7-2

Bonar, CAME
Bye
Bonar, CAME Bye

Round 1

Hatfield, CAMI
Browning, PHS 1063
Hatfield, CAMI
Fall 1:08

Showalter, PHS
Miller, CAME 1064
Showalter, PHS
MD 10-0

Green, GWS
Wright, NOMA 1065
Green, GWS
Fall 2:47

Pester, WCH
Dobbins, PRHS 1066
Pester, WCH
Fall 3:00

Round 2

Hatfield, CAMI
Pester, WCH 1153
Hatfield, CAMI
Fall 1:21

Showalter, PHS
Browning, PHS 1154
Showalter, PHS
Fall 0:26

Green, GWS
Dobbins, PRHS 1155
Green, GWS
Fall 3:30

Miller, CAME
Wright, NOMA 1156
Miller, CAME
Fall 0:42

Round 3

Hatfield, CAMI
Miller, CAME 1243
Hatfield, CAMI
TF-1.5 4:21 (19-4)

Showalter, PHS
Green, GWS 1244
Showalter, PHS
TF-1.5 4:05 (15-0)

Browning, PHS
Dobbins, PRHS 1245
Dobbins, PRHS
TF-1.5 4:20 (15-0)

Pester, WCH
Wright, NOMA 1246
Pester, WCH
Fall 2:17

Round 4

Hatfield, CAMI
Wright, NOMA 1333
Hatfield, CAMI
Fall 0:25

Showalter, PHS
Pester, WCH 1334
Showalter, PHS
Fall 1:04

Green, GWS
Browning, PHS 1335
Green, GWS
Fall 0:47

Miller, CAME
Dobbins, PRHS 1336
Miller, CAME
Fall 0:30

Round 5

Hatfield, CAMI
Green, GWS 1423
Hatfield, CAMI
Fall 2:27

Showalter, PHS
Dobbins, PRHS 1424
Showalter, PHS
Fall 0:41

Miller, CAME
Pester, WCH 1425
Miller, CAME
Fall 2:47

Browning, PHS
Wright, NOMA 1426
Wright, NOMA
Fall 2:56

Round 6

Hatfield, CAMI
Dobbins, PRHS 1513
Hatfield, CAMI
Fall 0:15

Showalter, PHS
Wright, NOMA 1514
Showalter, PHS
Fall 1:09

Green, GWS
Pester, WCH 1515
Green, GWS
M. For.

Miller, CAME
Browning, PHS 1516
Miller, CAME
Fall 0:16

Round 7

Hatfield, CAMI
Showalter, PHS 2077
Hatfield, CAMI
Fall 0:47

Green, GWS
Miller, CAME 2078
Miller, CAME
MD 10-2

Browning, PHS
Pester, WCH 2079
Browning, PHS
M. For.

Wright, NOMA
Dobbins, PRHS 2080
Dobbins, PRHS
Fall 2:58



Round 1

Wallace, CAME
Stephens, PHS 1067
Wallace, CAME
Fall 1:08

Dunham, HUNT
Sumpster, WCH 1068
Dunham, HUNT
Fall 5:11

Diaz, EFH
Hill, CAME 1069
Diaz, EFH
Fall 2:42

Andis, MORG
Bye
Andis, MORG
Bye

Round 2

Wallace, CAME
Andis, MORG 1157
Wallace, CAME
Fall 1:04

Dunham, HUNT
Stephens, PHS 1158
Dunham, HUNT
Fall 1:30

Diaz, EFH
Bye
Diaz, EFH
Bye

Sumpster, WCH
Hill, CAME 1159
Sumpster, WCH
Fall 1:01

Round 3

Wallace, CAME
Sumpster, WCH 1247
Wallace, CAME
Fall 1:14

Dunham, HUNT
Diaz, EFH 1248
Dunham, HUNT
MD 13-5

Stephens, PHS
Bye
Stephens, PHS
Bye

Andis, MORG
Hill, CAME 1249
Andis, MORG
Fall 0:54

Round 4

Wallace, CAME
Hill, CAME 1337
Wallace, CAME
Fall 0:23

Dunham, HUNT
Andis, MORG 1338
Dunham, HUNT
Fall 1:13

Diaz, EFH
Stephens, PHS 1339
Diaz, EFH
TF-1.5 2:39 (18-1)

Sumpster, WCH
Bye
Sumpster, WCH
Bye

Round 5

Wallace, CAME
Diaz, EFH 1427
Wallace, CAME
Dec 10-4

Dunham, HUNT
Bye
Dunham, HUNT
Bye

Sumpster, WCH
Andis, MORG 1428
Sumpster, WCH
Dec 8-5

Stephens, PHS
Hill, CAME 1429
Stephens, PHS
Fall 1:07

Round 6

Wallace, CAME
Bye
Wallace, CAME
Bye

Dunham, HUNT
Hill, CAME 1517
Dunham, HUNT
Fall 0:27

Diaz, EFH
Andis, MORG 1518
Diaz, EFH
Inj. 0:00

Sumpster, WCH
Stephens, PHS 1519
Sumpster, WCH
TF-1.5 3:38 (17-1)

Round 7

Wallace, CAME
Dunham, HUNT 2081
Wallace, CAME
Dec 7-2

Diaz, EFH
Sumpster, WCH 2082
Diaz, EFH
Fall 4:32

Stephens, PHS
Andis, MORG 2083
Stephens, PHS
M. For.

Hill, CAME
Bye
Hill, CAME
Bye

Round 1

Turner, PRHS
Sellaro, MORG
1070
Turner, PRHS
Fall 1:42

Kohl, CAMI
Haney, MORG
1071
Kohl, CAMI
Fall 2:33

Dvorak, WOWI
Castillo, BUUP
1072
Dvorak, WOWI
Fall 1:01

Marks, PHS
Newbold, MORG
1073
Marks, PHS
TF-1.5 1:08 (15-0)

Round 2

Turner, PRHS
Marks, PHS
1160
Turner, PRHS
Fall 1:00

Kohl, CAMI
Sellaro, MORG
1161
Kohl, CAMI
Fall 1:48

Dvorak, WOWI
Newbold, MORG
1162
Dvorak, WOWI
TF-1.5 1:41 (16-1)

Haney, MORG
Castillo, BUUP
1163
Haney, MORG
Fall 0:48

Round 3

Turner, PRHS
Haney, MORG
1250
Turner, PRHS
TF-1.5 2:07 (17-0)

Kohl, CAMI
Dvorak, WOWI
1251
Kohl, CAMI
Fall 1:33

Sellaro, MORG
Newbold, MORG
1252
Sellaro, MORG
Fall 1:13

Marks, PHS
Castillo, BUUP
1253
Marks, PHS
Fall 0:37

Round 4

Turner, PRHS
Castillo, BUUP
1340
Turner, PRHS
Fall 0:43

Kohl, CAMI
Marks, PHS
1341
Kohl, CAMI
Fall 1:59

Dvorak, WOWI
Sellaro, MORG
1342
Dvorak, WOWI
Fall 0:58

Haney, MORG
Newbold, MORG
1343
Haney, MORG
Fall 0:40

Round 5

Turner, PRHS
Dvorak, WOWI
1430
Turner, PRHS
Fall 1:10

Kohl, CAMI
Newbold, MORG
1431
Kohl, CAMI
Fall 0:25

Haney, MORG
Marks, PHS
1432
Marks, PHS
TF-1.5 1:20 (15-0)

Sellaro, MORG
Castillo, BUUP
1433
Sellaro, MORG
Fall 1:01

Round 6

Turner, PRHS
Newbold, MORG
1520
Turner, PRHS
TF-1.5 1:09 (17-2)

Kohl, CAMI
Castillo, BUUP
1521
Kohl, CAMI
Fall 0:35

Dvorak, WOWI
Marks, PHS
1522
Marks, PHS
Fall 1:15

Haney, MORG
Sellaro, MORG
1523
Haney, MORG
Fall 2:17

Round 7

Turner, PRHS
Kohl, CAMI
2084
Kohl, CAMI
SV-1 16-13

Dvorak, WOWI
Haney, MORG
2085
Haney, MORG
Fall 2:39

Sellaro, MORG
Marks, PHS
2086
Marks, PHS
Fall 1:20

Castillo, BUUP
Newbold, MORG
2087
Newbold, MORG
Fall 2:59

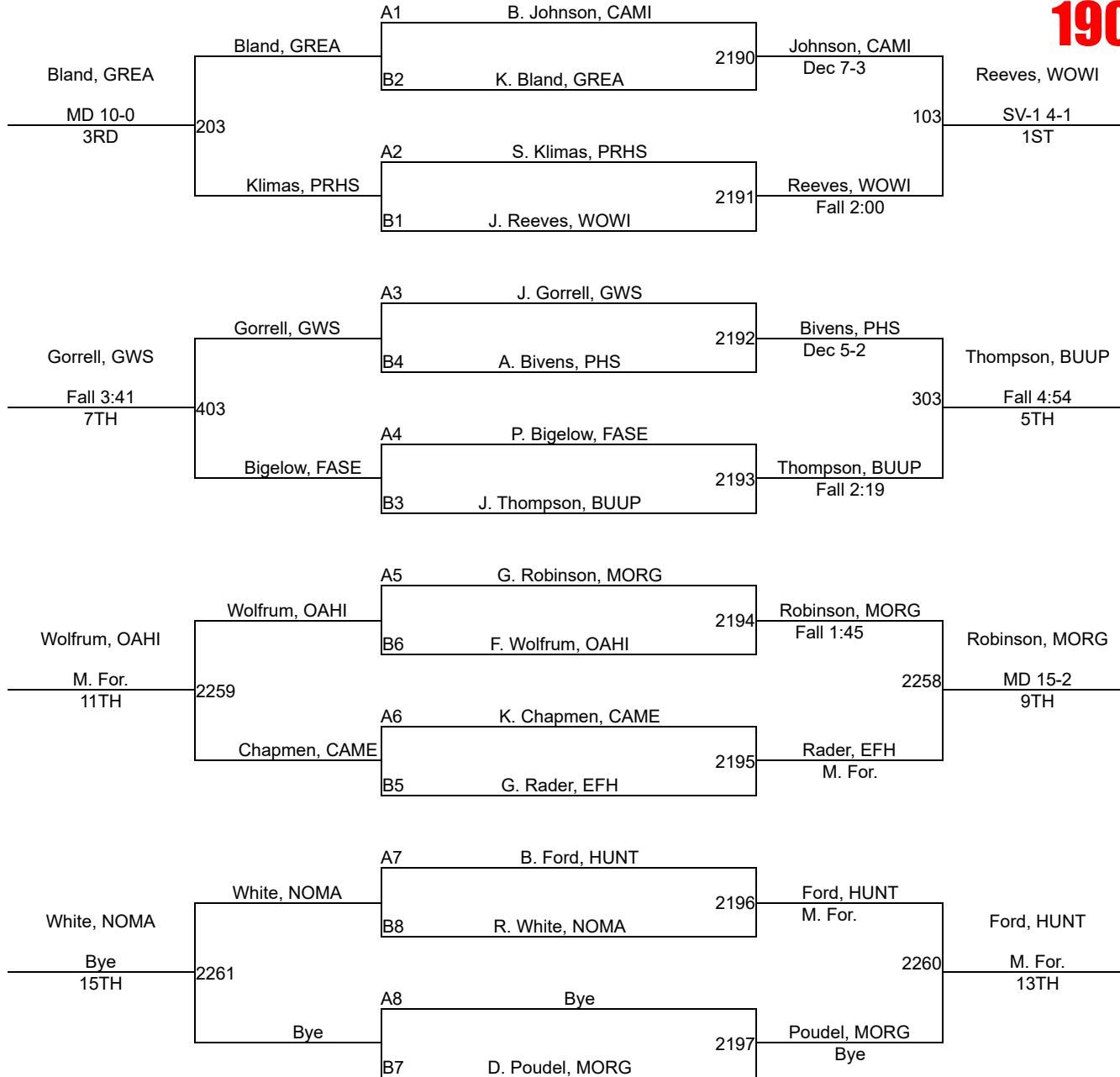

Round 1

Johnson, CAMI
Bye
Johnson, CAMI
Bye

Gorrell, GWS
1074
Gorrell, GWS
Fall 3:50
Robinson, MORG

Klimas, PRHS
1075
Klimas, PRHS
Fall 0:56
Bigelow, FASE

Chapmen, CAME
1076
Chapmen, CAME
Fall 3:02
Ford, HUNT

Round 2

Johnson, CAMI
1164
Johnson, CAMI
Fall 0:25
Chapmen, CAME

Gorrell, GWS
Bye
Gorrell, GWS
Bye

Klimas, PRHS
1165
Klimas, PRHS
Fall 1:05
Ford, HUNT

Robinson, MORG
1166
Bigelow, FASE
Fall 1:22
Bigelow, FASE

Round 3

Johnson, CAMI
1254
Johnson, CAMI
Fall 1:41
Robinson, MORG

Gorrell, GWS
1255
Klimas, PRHS
Fall 5:23
Klimas, PRHS

Bye
Ford, HUNT
Bye
Ford, HUNT

Chapmen, CAME
1256
Bigelow, FASE
Fall 1:48
Bigelow, FASE

Round 4

Johnson, CAMI
1344
Johnson, CAMI
Fall 0:27
Bigelow, FASE

Gorrell, GWS
1345
Gorrell, GWS
Fall 1:11
Chapmen, CAME

Klimas, PRHS
Bye
Klimas, PRHS
Bye

Robinson, MORG
1346
Robinson, MORG
Fall 1:50
Ford, HUNT

Round 5

Johnson, CAMI
1434
Johnson, CAMI
MD 14-3
Klimas, PRHS

Gorrell, GWS
1435
Gorrell, GWS
TF-1.5 3:26 (19-3)
Ford, HUNT

Robinson, MORG
1436
Robinson, MORG
Fall 1:45
Chapmen, CAME

Bye
Bigelow, FASE
Bye
Bigelow, FASE

Round 6

Johnson, CAMI
1524
Johnson, CAMI
Fall 1:01
Ford, HUNT

Gorrell, GWS
1525
Gorrell, GWS
Fall 5:59
Bigelow, FASE

Klimas, PRHS
1526
Klimas, PRHS
M. For.
Chapmen, CAME

Robinson, MORG
Bye
Robinson, MORG
Bye

Round 7

Johnson, CAMI
2088
Johnson, CAMI
Fall 1:07
Gorrell, GWS

Klimas, PRHS
2089
Klimas, PRHS
Fall 3:19
Robinson, MORG

Bye
Chapmen, CAME
Bye
Chapmen, CAME

Bigelow, FASE
2090
Bigelow, FASE
Fall 5:17
Ford, HUNT

Round 1

Reeves, WOWI
White, NOMA 1077
Reeves, WOWI
Fall 1:53

Bland, GREA
Bivens, PHS 1078
Bland, GREA
Fall 4:56

Thompson, BUUP
Rader, EFH 1079
Thompson, BUUP
Dec 4-0

Wolfrum, OAHl
Poudel, MORG 1080
Wolfrum, OAHl
Fall 0:43

Round 2

Reeves, WOWI
Wolfrum, OAHl 1167
Reeves, WOWI
Fall 2:36

Bland, GREA
White, NOMA 1168
Bland, GREA
Inj. 4:28

Thompson, BUUP
Poudel, MORG 1169
Thompson, BUUP
Fall 1:55

Bivens, PHS
Rader, EFH 1170
Bivens, PHS
MD 10-2

Round 3

Reeves, WOWI
Bivens, PHS 1257
Reeves, WOWI
Fall 2:40

Bland, GREA
Thompson, BUUP 1258
Bland, GREA
Dec 8-1

White, NOMA
Poudel, MORG 1259
Poudel, MORG
M. For.

Wolfrum, OAHl
Rader, EFH 1260
Rader, EFH
Fall 3:27

Round 4

Reeves, WOWI
Rader, EFH 1347
Reeves, WOWI
Fall 1:59

Bland, GREA
Wolfrum, OAHl 1348
Bland, GREA
Fall 1:28

Thompson, BUUP
White, NOMA 1349
Thompson, BUUP
M. For.

Bivens, PHS
Poudel, MORG 1350
Bivens, PHS
Fall 1:11

Round 5

Reeves, WOWI
Thompson, BUUP 1437
Reeves, WOWI
Dec 5-3

Bland, GREA
Poudel, MORG 1438
Bland, GREA
Fall 1:57

Bivens, PHS
Wolfrum, OAHl 1439
Bivens, PHS
Fall 2:42

White, NOMA
Rader, EFH 1440
Rader, EFH
M. For.

Round 6

Reeves, WOWI
Poudel, MORG 1527
Reeves, WOWI
Fall 0:24

Bland, GREA
Rader, EFH 1528
Bland, GREA
MD 12-0

Thompson, BUUP
Wolfrum, OAHl 1529
Thompson, BUUP
Fall 1:37

Bivens, PHS
White, NOMA 1530
Bivens, PHS
M. For.

Round 7

Reeves, WOWI
Bland, GREA 2091
Reeves, WOWI
Dec 4-1

Thompson, BUUP
Bivens, PHS 2092
Thompson, BUUP
Fall 3:50

White, NOMA
Wolfrum, OAHl 2093
Wolfrum, OAHl
M. For.

Rader, EFH
Poudel, MORG 2094
Rader, EFH
For.

Winner`s Choice

215

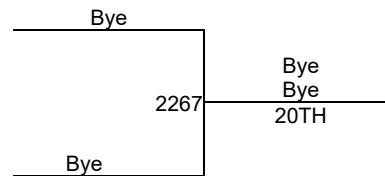
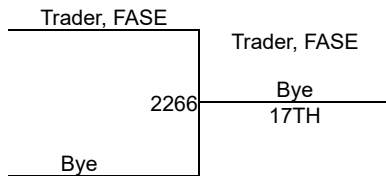
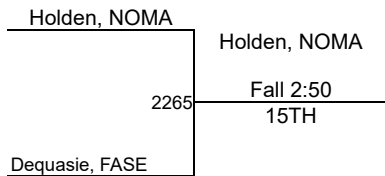
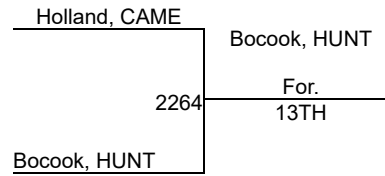
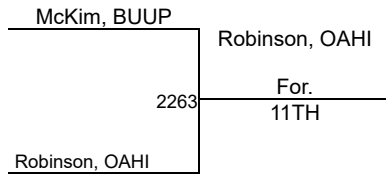
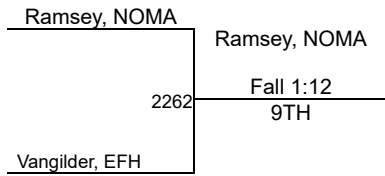
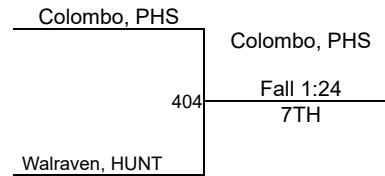
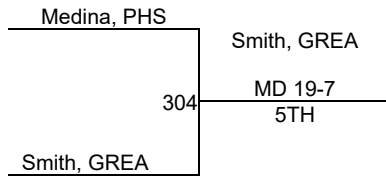
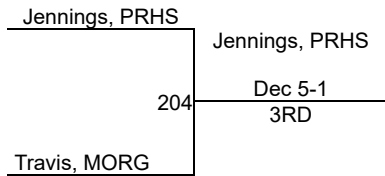
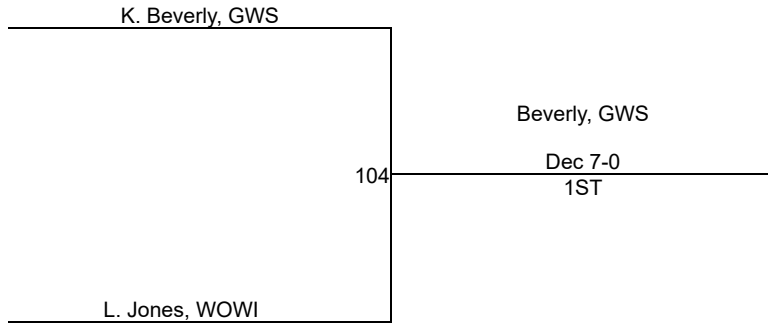

Round 1

Beverly, GWS
Medina, PHS 1009
Beverly, GWS
Fall 1:02

Ramsey, NOMA
Bye
Ramsey, NOMA
Bye

Holland, CAME
Jennings, PRHS 1010
TF-1.5 1:51 (17-2)

Trader, FASE
McKim, BUUP 1011
Fall 0:37

Holden, NOMA
Colombo, PHS 1012
Fall 1:10

Round 2

Beverly, GWS
Trader, FASE 1099
Beverly, GWS
Fall 1:25

Medina, PHS
Holland, CAME 1100
Medina, PHS
Fall 5:06

Ramsey, NOMA
Holden, NOMA 1101
Ramsey, NOMA
Fall 0:33

Colombo, PHS
Jennings, PRHS 1102
Dec 7-4

McKim, BUUP
Bye
McKim, BUUP
Bye

Round 3

Beverly, GWS
McKim, BUUP 1189
Beverly, GWS
Fall 1:12

Medina, PHS
Colombo, PHS 1190
Medina, PHS
Fall 5:17

Ramsey, NOMA
Jennings, PRHS 1191
Fall 2:54

Holland, CAME
Trader, FASE 1192
Holland, CAME
Fall 4:39

Holden, NOMA
Bye
Holden, NOMA
Bye

Round 4

Beverly, GWS
Bye
Beverly, GWS
Bye

Medina, PHS
Ramsey, NOMA 1279
Medina, PHS
MD 13-4

Holland, CAME
McKim, BUUP 1280
Fall 5:33

Trader, FASE
Colombo, PHS 1281
Fall 4:27

Holden, NOMA
Jennings, PRHS 1282
Fall 0:54

Round 5

Beverly, GWS
Holland, CAME 1369
Beverly, GWS
Fall 1:12

Medina, PHS
Holden, NOMA 1370
Medina, PHS
Fall 1:07

Ramsey, NOMA
Trader, FASE 1371
Ramsey, NOMA
Fall 4:49

Colombo, PHS
McKim, BUUP 1372
Inj. 2:00

Jennings, PRHS
Bye
Jennings, PRHS
Bye

Round 6

Beverly, GWS
Colombo, PHS 1459
Beverly, GWS
Fall 0:49

Medina, PHS
Jennings, PRHS 1460
Jennings, PRHS
Fall 4:37

Ramsey, NOMA
McKim, BUUP 1461
Ramsey, NOMA
Inj. 0:00

Holland, CAME
Bye
Holland, CAME
Bye

Trader, FASE
Holden, NOMA 1462
Fall 2:51

Round 7

Beverly, GWS
Ramsey, NOMA 2021
Beverly, GWS
Fall 0:46

Medina, PHS
Bye
Medina, PHS
Bye

Holland, CAME
Colombo, PHS 2022
Fall 0:56

Trader, FASE
Jennings, PRHS 2023
Fall 1:40

Holden, NOMA
McKim, BUUP 2024
For.

Round 8

Beverly, GWS
Holden, NOMA 2111
Beverly, GWS
Fall 1:54

Medina, PHS
Trader, FASE 2112
Medina, PHS
Fall 5:15

Ramsey, NOMA
Holland, CAME 2113
Ramsey, NOMA
Fall 2:00

Colombo, PHS
Bye
Colombo, PHS
Bye

McKim, BUUP
Jennings, PRHS 2114
M. For.

Round 9

Beverly, GWS
Jennings, PRHS 2206
Beverly, GWS
Fall 1:49

Medina, PHS
McKim, BUUP 2207
M. For.

Ramsey, NOMA
Colombo, PHS 2208
Colombo, PHS
Dec 6-3

Holland, CAME
Holden, NOMA 2209
Holland, CAME
Fall 1:26

Trader, FASE
Bye
Trader, FASE
Bye

Jones, WOWI	Jones, WOWI
Robinson, 1013 OAH	TF-1.5 2:24 (18-0)

Walraven, HUNT	Walraven, HUNT
Bye	Bye

Round 1

Dequasie, FASE	Travis, MORG
Travis, 1014 MORG	Fall 3:25

Bye	Smith, GREA
Smith, GREA	Bye

215

Vangilder, EFH	Vangilder, EFH
Bocook, 1015 HUNT	TF-1.5 2:40 (15-0)

Jones, WOWI	Jones, WOWI
Bye	Bye

Robinson, OAH	Robinson, OAH
Dequasie, 1103 FASE	Fall 3:11

Round 2

Walraven, HUNT	Walraven, HUNT
Vangilder, 1104 EFH	Fall 1:52

Bocook, HUNT	Travis, MORG
Travis, 1105 MORG	TF-1.5 5:12 (19-3)

Smith, GREA	Smith, GREA
Bye	Bye

Jones, WOWI	Jones, WOWI
Smith, 1193 GREA	Fall 0:44

Robinson, OAH	Robinson, OAH
Bocook, 1194 HUNT	Dec 11-6

Round 3

Walraven, HUNT	Travis, MORG
Travis, 1195 MORG	Dec 3-1

Dequasie, FASE	Dequasie, FASE
Bye	Bye

Vangilder, EFH	Vangilder, EFH
Bye	Bye

Jones, WOWI	Jones, WOWI
Bye	Bye

Robinson, OAH	Walraven, HUNT
Walraven, 1283 HUNT	Fall 2:28

Round 4

Dequasie, FASE	Smith, GREA
Smith, 1284 GREA	Fall 1:07

Bye	Bocook, HUNT
Bocook, HUNT	Bye

Vangilder, EFH	Travis, MORG
Travis, 1285 MORG	Dec 10-4

Jones, WOWI	Jones, WOWI
Dequasie, 1373 FASE	Fall 0:52

Robinson, OAH	Vangilder, EFH
Vangilder, 1374 EFH	Dec 7-5

Round 5

Walraven, HUNT	Walraven, HUNT
Bye	Bye

Bocook, HUNT	Smith, GREA
Smith, 1375 GREA	Fall 0:55

Travis, MORG	Travis, MORG
Bye	Bye

Jones, WOWI	Jones, WOWI
Bocook, 1463 HUNT	Fall 1:02

Robinson, OAH	Travis, MORG
Travis, 1464 MORG	MD 11-0

Round 6

Walraven, HUNT	Smith, GREA
Smith, 1465 GREA	Fall 4:52

Dequasie, FASE	Dequasie, FASE
Bye	Bye

Bye	Vangilder, EFH
Vangilder, EFH	Bye

Jones, WOWI	Jones, WOWI
Walraven, 2025 HUNT	Fall 0:54

Robinson, OAH	Robinson, OAH
Bye	Bye

Round 7

Dequasie, FASE	Bocook, HUNT
Bocook, 2026 HUNT	TF-1.5 4:51 (21-6)

Bye	Travis, MORG
Travis, MORG	Bye

Vangilder, EFH	Smith, GREA
Smith, 2027 GREA	Fall 1:00

Jones, WOWI	Jones, WOWI
Vangilder, 2115 EFH	Fall 0:53

Robinson, OAH	Robinson, OAH
Bye	Bye

Round 8

Walraven, HUNT	Walraven, HUNT
Dequasie, 2116 FASE	Fall 3:52

Bocook, HUNT	Bocook, HUNT
Bye	Bye

Smith, GREA	Travis, MORG
Travis, 2117 MORG	SV-1 4-1

Jones, WOWI	Jones, WOWI
Travis, 2210 MORG	TF-1.5 2:23 (17-1)

Robinson, OAH	Robinson, OAH
Smith, 2211 GREA	Dec 4-0

Round 9

Walraven, HUNT	Walraven, HUNT
Bocook, 2212 HUNT	Fall 0:33

Dequasie, FASE	Vangilder, EFH
Vangilder, 2213 EFH	Fall 4:43

Bye	Bye
Bye	Bye

Winner`s Choice

POOL A		Round 1	Round 2	Round 3	Round 4	Round 5
1	J. Payne, GWS	2 / Bout 1085 Payne Fall 0:52	3 / Bout 1175 Payne Fall 0:50	4 / Bout 1265 Payne Fall 5:43	5 / Bout 1355 Payne Fall 0:40	6 / Bout 1445 Payne Dec 7-1
2	T. Vaughn, HUNT	1 / Bout 1085 Payne Fall 0:52	5 / Bout 1176 Fisher MD 11-2	6 / Bout 1266 Abercrombi Fall 0:34	4 / Bout 1356 Shipman Fall 3:29	3 / Bout 1446 Yost-Lewel Fall 5:32
3	L. Yost-Lewel, WCH	4 / Bout 1086 Shipman Dec 4-1	1 / Bout 1175 Payne Fall 0:50	5 / Bout 1267 Yost-Lewel Dec 1-0	6 / Bout 1357 Abercrombi Fall 3:10	2 / Bout 1446 Yost-Lewel Fall 5:32
4	Z. Shipman, MORG	3 / Bout 1086 Shipman Dec 4-1	6 / Bout 1177 Abercrombi Dec 7-4	1 / Bout 1265 Payne Fall 5:43	2 / Bout 1356 Shipman Fall 3:29	5 / Bout 1447 Shipman Dec 2-0
5	L. Fisher, WCH	6 / Bout 1087 Abercrombi Fall 0:48	2 / Bout 1176 Fisher MD 11-2	3 / Bout 1267 Yost-Lewel Dec 1-0	1 / Bout 1355 Payne Fall 0:40	4 / Bout 1447 Shipman Dec 2-0
6	K. Abercrombi, FASE	5 / Bout 1087 Abercrombi Fall 0:48	4 / Bout 1177 Abercrombi Dec 7-4	2 / Bout 1266 Abercrombi Fall 0:34	3 / Bout 1357 Abercrombi Fall 3:10	1 / Bout 1445 Payne Dec 7-1

POOL B		Round 1	Round 2	Round 3	Round 4	Round 5
1	H. Rogers, NOMA	2 / Bout 1088 Rogers Fall 5:48	3 / Bout 1178 Rogers Fall 0:11	4 / Bout 1268 Edens DQ	5 / Bout 1358 Cole For.	6 / Bout 1448 Apanowicz For.
2	T. West, WOWI	1 / Bout 1088 Rogers Fall 5:48	5 / Bout 1179 West Fall 4:23	6 / Bout 1269 Apanowicz Dec 3-0	4 / Bout 1359 Edens MD 8-0	3 / Bout 1449 West Fall 3:49
3	M. Hawkins, BUUP	4 / Bout 1089 Edens Fall 0:49	1 / Bout 1178 Rogers Fall 0:11	5 / Bout 1270 Cole Fall 3:01	6 / Bout 1360 Apanowicz Fall 2:45	2 / Bout 1449 West Fall 3:49
4	B. Edens, CAMI	3 / Bout 1089 Edens Fall 0:49	6 / Bout 1180 Edens Dec 10-6	1 / Bout 1268 Edens DQ	2 / Bout 1359 Edens MD 8-0	5 / Bout 1450 Edens Fall 1:18
5	H. Cole, PRHS	6 / Bout 1090 Apanowicz Fall 1:33	2 / Bout 1179 West Fall 4:23	3 / Bout 1270 Cole Fall 3:01	1 / Bout 1358 Cole For.	4 / Bout 1450 Edens Fall 1:18
6	D. Apanowicz, FASE	5 / Bout 1090 Apanowicz Fall 1:33	4 / Bout 1180 Edens Dec 10-6	2 / Bout 1269 Apanowicz Dec 3-0	3 / Bout 1360 Apanowicz Fall 2:45	1 / Bout 1448 Apanowicz For.

